

# HANDBOOK & EQUIPMENT GUIDE for EXTERNAL CONCRETE VIBRATORS

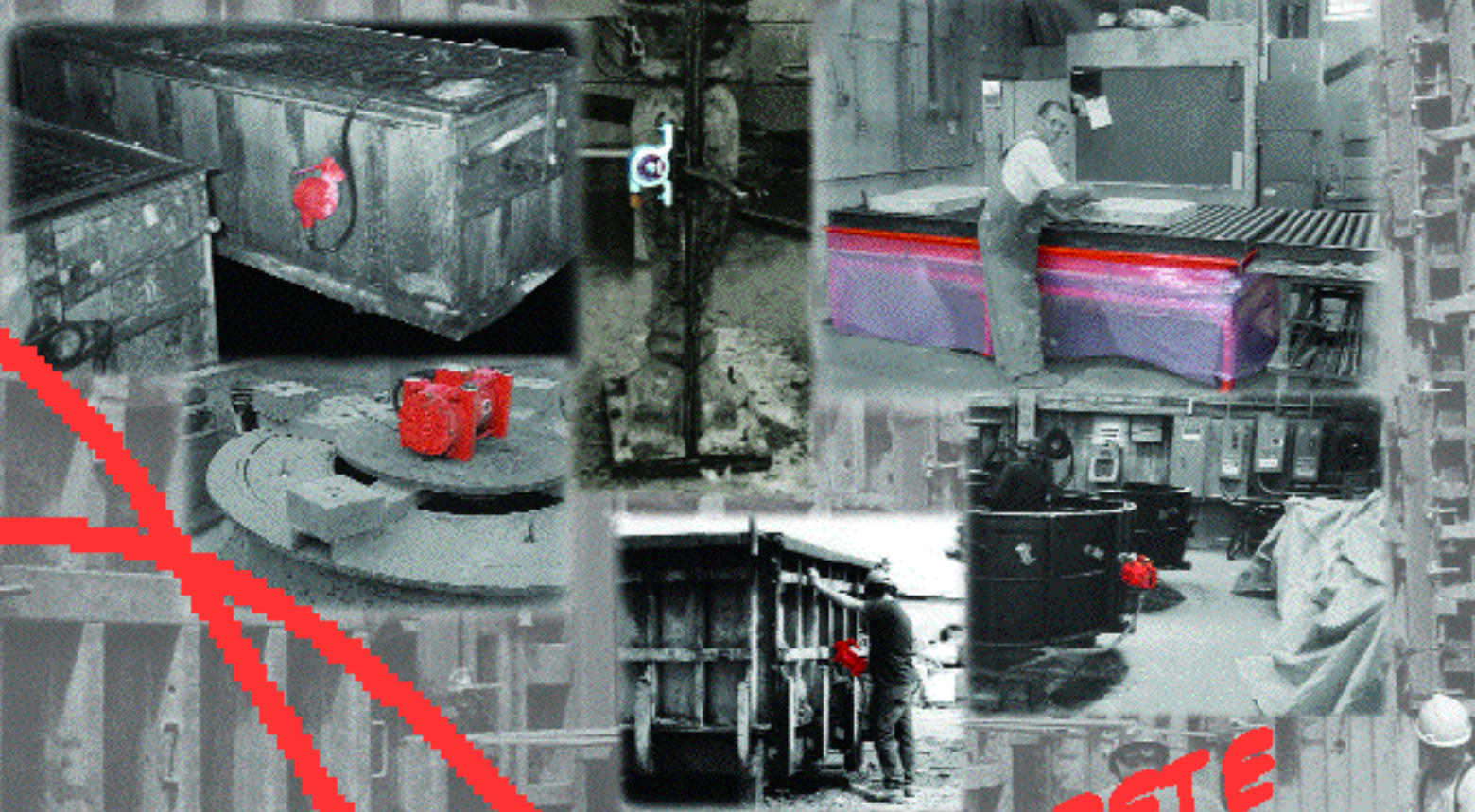

**CONCRETE**  
We're The Vibrator Guys.™

# VIBCO

[www.vibco.com](http://www.vibco.com)

WE'RE THE <sup>CONCRETE</sup> VIBRATOR GUYS



Made in the U.S.A.

# VIBCO

## VIBRATION PRODUCTS

Look for **Silent Sam** throughout the catalog for interesting information about **VIBCO** and the products & services we offer!

**Bet you didn't know!**



**VIBCO CONCRETE VIBRATORS**  
INTERNAL • EXTERNAL • AIR • ELECTRIC  
**VIBRATORS**

WE'RE THE <sup>CONCRETE</sup> VIBRATOR GUYS



**CHUTE VIBRATORS**  
CHARGE HOPPER VIBRATORS

### Product Information:

Wedge Brackets .....	pgs.	2 - 5
Lug Brackets .....	pgs.	6 - 7
Steel Form Brackets .....	pgs.	8-10
Wood Form Brackets .....	pg.	11
Bracket-Model Reference Chart .....	pg.	13
Pneumatic Vibrators .....	pgs.	14 - 15
Electric Vibrators .....	pgs.	16 - 17
General Rules for Vibrator Use .....	pgs.	18 - 19

### Engineering Data & Applications:

Precast Forms .....	pgs.	20 - 25
Septic Tanks & Burial Vaults .....	pgs.	26 - 28
Concrete Steps .....	pg.	29
Ornamental Concrete .....	pgs.	30 - 32
Vibratory Tables & Stands .....	pgs.	33 - 36
Screeds, Tamper & Trowels .....	pgs.	37 - 39
Pipe Forms .....	pgs.	40 - 43
Pumps, Bins & Hoppers .....	pgs.	44 - 47

# VIBCO HANDBOOK AND VIBRATION EQUIPMENT GUIDE

## **THIS IS VIBCO:**

A name for quality and service you can depend on. VIBCO was incorporated in 1962 and has become an industry leader in vibration problem solving and system know how.

Qualified engineers with years of experience in the vibration field assure you of the latest developments in vibration engineering. Well trained craftsmen put these developments into the most reliable and long lasting vibration equipment available today. Our guarantee assures you of our confidence in and the reliability of our products.

## **“PERFECT EVERY TIME”**

This VIBRATION HANDBOOK & EQUIPMENT GUIDE will give you a general idea of how to solve most concrete application problems. For additional information and application assistance contact VIBCO'S Application Engineers at **800-633-0032** or at **vibrators@vibco.com**. See us online at **www.vibco.com**.

## **PORTABLE FORM VIBRATORS & BRACKETS**

VIBCO'S external form vibrators are lightweight and portable. Available in electric, 115 volt plug-in and air models, they produce higher strength, smoother finished concrete with less cement, less casting time and less labor than internal vibrators. VIBCO'S external vibrators put the force where needed, giving faster concrete placement and blemish-free, void-free finishes. No more scarring as with internals. Ideal and economical for both the small and large producer. Can be used on all types of forms and tables, including patio blocks, septic tanks, burial vaults, steps, manholes, wall panels, columns, beams, etc. VIBCO offers the widest choice of air and electric, low and high frequency vibrators and brackets available anywhere. Free-trial on your own form. Consult our engineering department on your next installation; over 40 years of experience with thousands of successful installations.

## **OUR GUARANTEE IS VERY SIMPLE:**



WE GUARANTEE OUR VIBRATORS TO PERFORM TO YOUR SATISFACTION OR THEY CAN BE RETURNED FOR FULL CREDIT OR EXCHANGED. We allow a 10 day trial at NO CHARGE to give you the opportunity to test the unit and make sure it does the job you intended it to do.

**ALL VIBCO VIBRATORS ARE MADE IN THE U.S.A.**

# WEDGE BRACKET VIBRATORS

## 4" WIDE WEDGE



**SVRWS-4000W**



**CCW-2000W**



**UWF-3**



**US-1600  
with UWF-3 BRACKET**

## 3" WIDE WEDGE



**US-900 with UW-2 BRACKET**



**VS-510 with WEDGE**

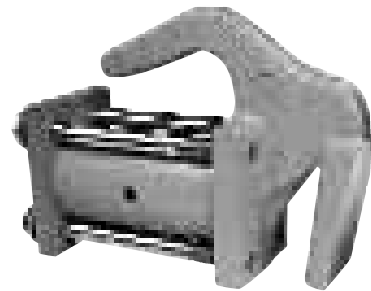

**42-2**

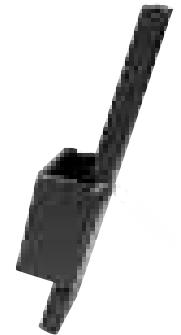

**UWF-1**

VIBCO produces 3" and 4" wide wedge brackets. The 3" models have been a standard in the industry for many years. The increased requirements for faster production and more powerful vibrators made it necessary to develop the stronger 4" wedge.

Two pneumatic units with the wedge as a permanent part of the unit were developed - Model CCW-2000W and SVRWS-4000W. The CCW-2000 needs no lubrication and is absolutely quiet, 75-80 dB, ideal in places where noise is objectionable. Model SVRWS-4000 is a high frequency unit and will produce a strong and architectural finish to the concrete together with a fast pour. The SVRWS as well as the 42-2" piston type vibrator need continuous lubrication.

Almost any vibrator can be adapted to the separate male bracket. The 115 volt models US-900 and US-1600 are the most popular ones. Their light weight and high frequency make them excellent units for obtaining high strength and architectural finish. For the smaller forms the 3" wedge is used with smaller vibrators such as the pneumatic turbine VS-line.

## TECHNICAL DATA

Model	Weight		80 PSI		100 PSI		lbs.	Force	N	dB
	lbs.	kg.	Speed VPM	CFM	Speed VPM	CFM				
CCW-2000	23	10.5	6000	35	-	-	2000	8900	78	
SVRWS-4000	23	10.5	11500	40	13500	40	4400	19500	82	
42-2	26	11.8	4500	18	-	-	1000	4449	85	

US-900, 1600 See Page 14 for Technical Data. VS-320, BVS-510 See Page 12 for Technical Data.

## DIMENSIONS\*

Model	L inch/mm		W inch/mm		H inch/mm		A inch/mm		B inch/mm		C inch/mm		R inch/mm
CCW-2000	6-7/8	175	7-3/4	197	7-1/8	181	-	-	2-3/8	60	5-1/8	130	3/4 NPT
SVRWS-4000	6-7/8	175	7-3/4	197	7-1/8	181	3/4	19	2-3/16	56	5-1/8	130	3/4 NPT
42-2	9-3/8	238	3-1/2	89	7-1/8	181	3/8	10	2-1/4	57	4-1/2	114	1/4 NPT
US-900	11-1/8	283	4-7/8	124	6-1/4	160	3-1/2	89	6-7/8	175	1/2	12	-
US-1600	11-1/4	286	5-5/8	143	5-5/8	143	4-1/2	114	7	178	1/2	12	-
VS-510	6-3/4	171	2-7/8	73	5-3/8	137	5-1/2 x 1-3/4 140 x 44		3/4	19	-	-	3/8 NPT

\* See page 3. NOTE: Dimensions and data subject to change without notice.

# 4" WIDE WEDGE BRACKET- PNEUMATIC VIBRATORS

- BETTER VIBRATION TRANSFER
- MORE HOLDING POWER
- STRONGER WEDGE
- PORTABLE - EASY ON, EASY OFF

**WIDER  
IS  
BETTER**



Use a hammer on top strike pad to secure or bottom strike pad to remove wedge in female bracket.



**MODEL CCW-4000**  
(air operated)

**MODEL SVRWS-4000W**  
(air operated)



**UWF-3  
FEMALE  
BRACKET**  
(attaches  
easily to forms)

## CONCRETE FORM VIBRATORS:

Wider wedge allows greater vibration transfer and more holding power allowing larger vibrators to be used. This will give you better consolidation of the concrete, better surface finish while using a stiffer mix. You can also make the UWF-3 bracket yourself. Drawings are available.

Model-SVRWS-4000W is a high frequency air vibrator producing 4000 lbs. of vibration force at 13,500 vibrations per minute. Air consumption 40 CFM. Weight 25 lbs.

Model CCW-4000 **Silent** Turbine Air Vibrator (78db), produces 4,000 lbs. of force at 7,300 vibrations per minute. Air consumption 40 CFM. Weight 23 lbs.

# 4" WIDE WEDGE BRACKET

## ELECTRIC VIBRATORS

- **BETTER VIBRATION TRANSFER TO CONCRETE**
- **MORE HOLDING POWER IN FEMALE BRACKET**
- **STRONGER WEDGE FOR GREATER VIBRATION FORCES - 4" vs. 3" WIDE**
- **STRIKE PAD FOR SECURING OR REMOVING UNIT**
- **ERGONOMIC DIAGONAL HANDLE FOR EASE IN HANDLING**

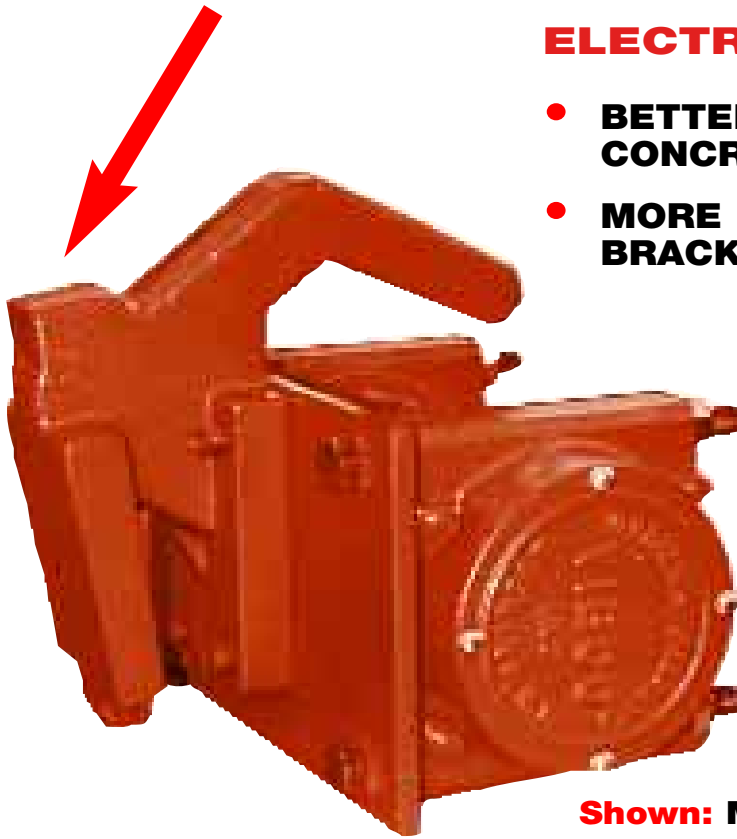

**Shown: MODEL US-1600 Electric 115 volt vibrator mounted with 4" wide wedge**

Use a mallet or hammer on VIBCO designed top strike pad to secure wedge into female bracket. (Usually only necessary when female bracket is worn.) To remove bracket use a mallet or hammer on bottom strike pad if wedge is pushed too far into female bracket.



### UWW-MALE BRACKET

(can be adapted to most electric & pneumatic units)

### UWF-3 FEMALE BRACKET

(attaches easily to forms)

**MOST COMMONLY USED BRACKET**

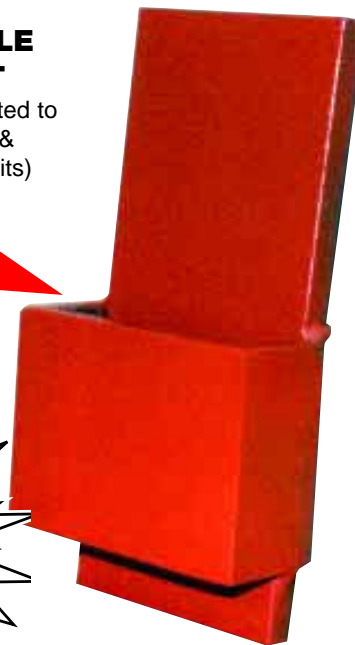

### DID YOU KNOW?

VIBCO will design custom form bracks for **YOUR** needs. And with VIBCO'S ENGINEERS, it's easy to work with **AN ENGINEER** looking up.



# BEST FOR STEEL FORMS 3" WIDE WEDGE BRACKETS

(90% VIBRATION TRANSFER)

## US-900 WITH UW-2 WEDGE BRACKET

See page 16 for  
technical data.

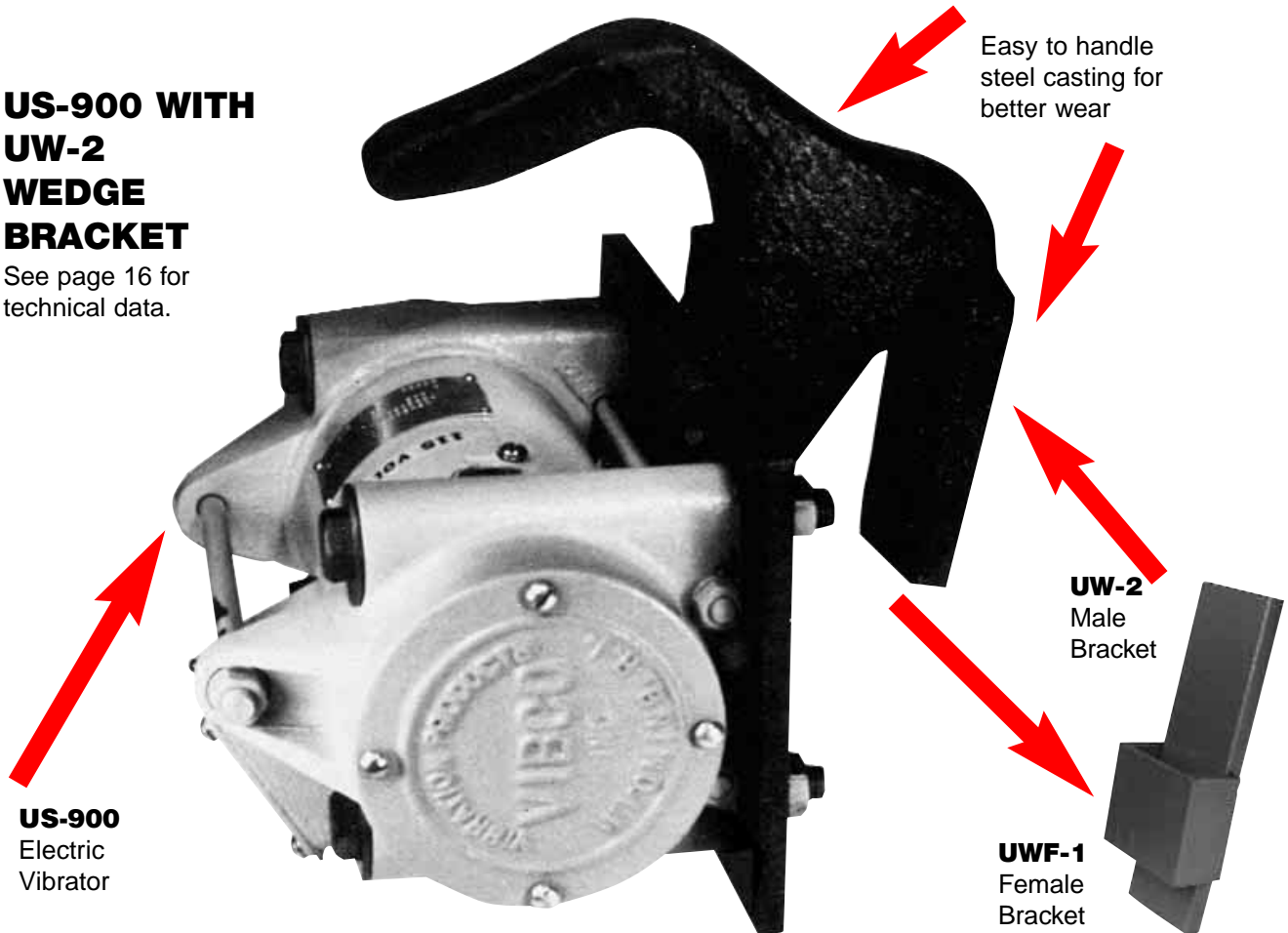

Easy to handle  
steel casting for  
better wear

**UW-2**  
Male  
Bracket

**UWF-1**  
Female  
Bracket

**US-900**  
Electric  
Vibrator

High frequency Model US-900 electric vibrator with 10,000 vibrations per minute (adjustable) and 900 lbs. of force (adjustable) 115 volt 3.5 amps. Plug in. On-off switch with overload protection on cord. Intermittent duty. (Duty cycle-30 min. operation in an hour).

## DIFFERENT MOUNTING SUGGESTIONS FOR UWF-BRACKET

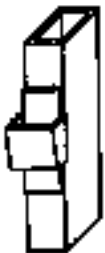

Most common mounting  
of UWF bracket.



Steel Channel - Add  
stiffener where UWF  
bracket is welded.



Angle Iron - Add a 2 x 2  
tube and angle iron as  
a stiffener.



Add a welded or bent  
steel saddle 1/8-1/4"  
over wood stiffener,  
secure it with thru bolts.

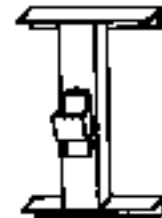

Horizontal Stiffener - add  
a 3 or 4" channel between  
stiffeners.

The wedge brackets are the most popular of VIBCO'S portable form brackets. The male wedge easily slips in and out of the UWF female pocket to give you simple handling & easy portability. Used on steel & wood forms. UWF bracket welds or bolts on. Pneumatic or electric vibrators can be used. See general catalog for other technical data.

# LUG TYPE BRACKETS

(100% VIBRATION TRANSFER)

**MODELS:**

- SVRLS-4000
- SVRLS-5500
- SVRLS-6500
- SVRLS-8000

VIBCO'S patented silent, high frequency air vibrator.

**MODEL SVRLS-4000**

Use LC-2 Bracket

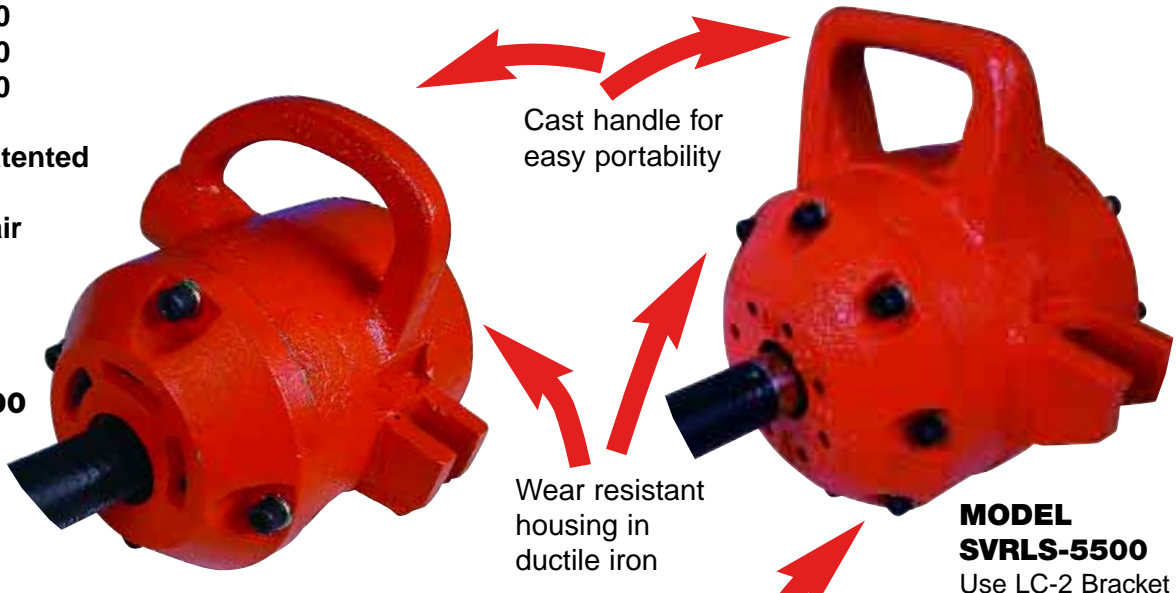

Cast handle for easy portability

Wear resistant housing in ductile iron

**MODEL SVRLS-5500**  
Use LC-2 Bracket

Swivel nut for ease of tightening

**Lug Bracket LC-1, LC-2**

Replaceable shaft nut & eyebolt



Patented air circulator covers

**USER NOTE:**

Weld mild steel rod both sides eliminate bracket breaking loose & fatigue cracks

The Lug Bracket has gained popularity in the concrete pipe and heavy concrete form field where a lot of force has to be transmitted to the form and ease of portability is essential. 95-100% of force created by the vibrator is transmitted to the form. VIBCO'S inexpensive lug bracket can be welded on in any location where additional vibration is needed. Replaceable parts make them last practically forever.

**ELECTRIC • PNEUMATIC • HYDRAULIC**



**USL-900 & -1600**  
use LC-2 Bracket



**2PL-900 & -1600**  
use LC-2 Bracket



**HL-3000**  
use LC-1 Bracket



**LC-1**



**SVRL & SVRLS -5500, -6500 & -8000**  
use LC-1 Bracket



**SVRLS -4000**  
use LC-2 Bracket



**CCL-5000**  
use LC-1 Bracket



**LC-2**



# LUG TYPE VIBRATORS

The lug type bracket has become more popular due to the fact that it secures the vibrator firmly and 95-100% of the vibration force is transmitted. There are two lug type brackets, the small LC-2 and the larger LC-1.

The SVR units with their high frequency and high force are used for the big jobs. They give a fast pour, high strength and an architectural surface finish. These pneumatic units operate at 9-12000 VPM and up to 100-110 PSI on lubricated air. These bearingless units have only one moving part and require a minimum of maintenance.

The CCL-2000, CCL-4000, CCL-5000 and CCL-7000 are turbine type vibrators with speeds up to 7000 VPM, absolutely quiet. Their bearings are prelubricated for life.

Model 2PL-900 and 2PL-1600 electrics are made in both single phase and three phase. USL-900 & USL-1600 are high frequency vibrators with 9000 to 10000 VPM. They are 115 volt and can be plugged into any light outlet or used with field generators. Speed can be adjusted with simple rheostats or electronic speed adjusters. Force is also adjustable with 3 force settings on the eccentrics.

Model HL- 3000 hydraulic is equipped with VIBCO's patented vibration isolation device, which eliminates vibration transfer from the vibrator part to the drive motor giving the motor bearings their full calculated life.

## TECHNICAL DATA

Electric Models	Phase	Amperes at Volt			H.P.	Force (Impact) lbs./N						Adjustable	dB**	Weight		RPM
		115/230	230/460	575		Min.		Norm.		Max.				lbs.	kg.	
		1 & 3	1 & 3	1 & 3		lbs.	N	lbs.	N	lbs.	N			lbs.	kg.	
2PL-900	1 & 3	3/1.5	1/1.5	—	1/3	15	667	300	1335	450	2002	62	30	13.6	3600	
2PL-1600	1 & 3	5/2.5	1.2/6	—	1/2	110	489	450	2002	900	4004	64	48	21.8	3600	
USL-900	1	4.5/-	—	—	—	600	2669	900	4004	1100	4894	85	18	8.2	10000	
USL-1600	1	5.0/-	—	—	—	1100	4894	1600	7118	1800	8008	85	20	9.1	9000	

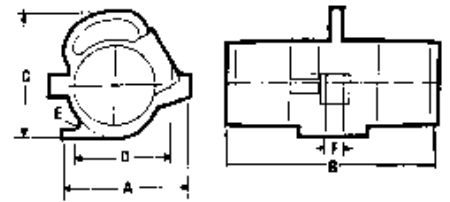

2PL USL

Pneumatic Models	Weight		80 PSI			90 PSI			100 PSI			CFM*	dB**
	lbs.	kg.	VPM*	Force lbs.	Force N	VPM*	Force lbs.	Force N	VPM*	Force lbs.	Force N		
SVRLS-4000	23	10.4	11500	3600	16000	12500	4000	17800	13500	4400	19500	40	78
SVRLS-5500	43	19.5	9000	4950	22000	10000	5500	24500	10500	6100	27100	54	78
SVRLS-6500	45	20.4	8800	5575	24800	9500	6500	28900	10000	7200	32000	58	80
SVRLS-8000	47	21.3	8500	7625	33900	8700	8000	35600	9500	9550	42500	62	82
SVRL-5500	37	16.8	9000	4950	22000	10800	5500	24500	10500	6100	27100	56	98
SVRL-6500	39	17.8	8800	5575	24800	9500	6500	28900	10000	7200	32000	60	98

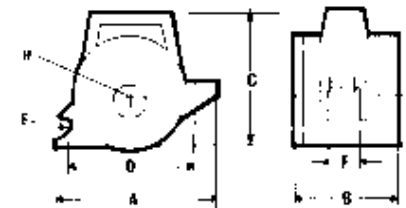

SVRLS HL

Pneumatic Models	Weight		60 PSI			80 PSI			CFM*	dB**
	lbs.	kg.	VPM*	Force lbs.	Force N	VPM*	Force lbs.	Force N		
CCL-2000,4000	23	10.5	880	880	3914	6000	2000/4000	8900/17996	35	78
CCL-5000,7000	48	21.8	2200	2200	9785	6000	5000/7000	22245/31143	40	75

Hydraulic Models	Weight		Avg. PSI (max. 3000 PSI)	VPM*	GPM (max.)	Force		dB**
	lbs.	kg.				lbs.	N	
HL-3000	39	17.7	1000	5000	3.2	3400	15124	76

\*Frequency and air consumption will vary with load. \*\*dB a 3' (1 meter) on A scale N = Centrifugal force in Newton.

## DIMENSIONS

Model	A	B	C	D	E	F	H	J	K	Brackets				
	inch/model	inch/model	inch/model	inch/model	inch/model	inch/model	inch/model	inch/model	inch/model					
2PL-900	7 1/8	12 3/8	7 1/8	5 1/2	1 25	—	—	—	1 1/16	LC-2				
2PL-1600	9 1/2	11 5/8	8 1/4	6 5/8	1 25	1 1/16	27	—	—	LC-1				
USL-900	7 1/2	11 1/8	7 1/4	4 3/4	3/4	19	7/8	22	—	LC-2				
USL-1600	7 7/8	11 279	7 1/4	4 3/4	3/4	19	7/8	22	—	LC-2				
SVRLS-4000	7 1/8	12 3/8	7 1/2	6 1/2	3/8	10	7/8	22	3/4	19	LC-2			
SVRLS-5500, 6500 & 8000	9 1/2	11 5/8	9 1/4	7 3/4	1 25	1 1/4	32	3/4	19	—	LC-1			
SVRL-5500, 6500 & 8000	9 1/2	11 5/8	9 1/4	7 3/4	1 25	1 1/4	32	3/4	19	—	LC-1			
CCL-2000, 4000	7 1/8	8 1/8	7 1/4	5 15/16	3/4	19	3/4	19	4 1/8	105	3/4-NPT	7 3/4	197	LC-2
CCL-5000, 7000	9 3/8	11 1/8	8 5/8	8	203	1 25	1 1/4	32	5 1/4	133	1-NPT	8 1/2	216	LC-1
HL-3000	9 1/2	11 1/4	9 1/4	7 3/4	1 25	1 1/4	32	—	—	—	—	—	—	LC-1

NOTE: Dimensions and data subject to change without notice.

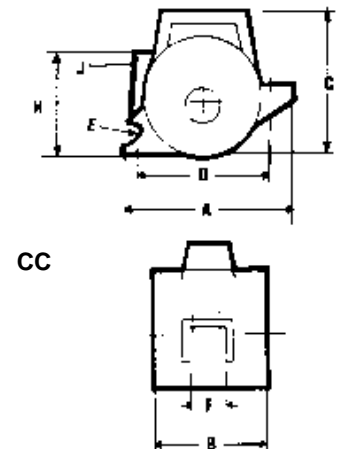

# STEEL FORMS SHOE BRACKETS

(90% VIBRATION TRANSFER)

**MODEL SVRS-5500  
& SB-SHOE BRACKET**

Handle bar  
for easier  
handling

Sturdy steel  
cast housing

Adapter  
bracket for  
bolt on style  
vibrators

Bracket steel  
casting

Cut out  
holes for  
easier  
welding to  
form

Rugged steel  
casted foot slides  
into shoe bracket

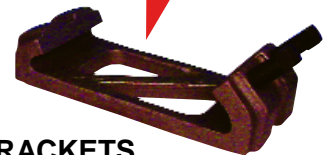
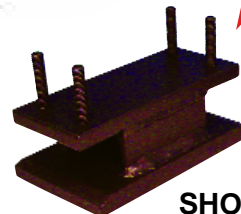

**SHOE BRACKETS**

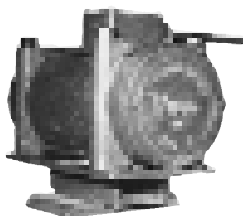

**2P-450** Electric (VMH-3)  
Adapter (See page 16  
for technical data)



**US-900** High Frequency  
Electric (UA-2) Adapter  
(See page 16 for  
technical data)



**SVR-4000** High Frequency  
Pneumatic (SVA-1) Adapter  
(See page 14 for  
technical data)



**BVS-510** Silent Pneumatic  
(BVH-2) Adapter (See page 14  
for technical data)

VIBCO's shoe brackets make portability easy with any type vibrator. A few are shown here, but practically any type vibrator can be used. Have VIBCO's engineers help you select a suitable vibrator for your application. SB shoe bracket is welded to channel stiffener or support beam. Vibrator with its adapter simply slides into bracket and is locked firmly by two hardened bolts.

# ROTARY PISTON BURIAL VAULT VIBRATOR

- BETTER FINISH • FASTER POUR • STRONGER CONCRETE

## STEEL FORMS – PIN BRACKETS (60-75% VIBRATION TRANSFER)

- Silent, meets OSHA regulations
- No lubrication needed
- Outlasts standard pistons 3 to 1
- Easily repaired; Not a throw away like standard piston vibrators



### **PNEUMATIC MODEL VSP-510**

FORCE: 1000 lbs.  
AIR. CONS: 21CFM  
at 80 PSI  
WEIGHT: 15 lbs.  
DIM: 7"L x 4"W x 8"H  
FREQUENCY: 4500 RPM



### **UPF-Female Bracket Welded To Form**

Model VSP-510 Pneumatic Silent Turbine design and USP-900 Electric 115 Volt Pin Bracket Vibrators give the concrete precast producer a silent vibrator that needs no lubrication and a 115 volt plug in electric vibrator. These units are primarily used by the burial vault producer. Their noiseless operation makes them ideal for operating anyplace or anytime without disturbance. Their high frequency and rotary force create up to 1000 lbs. of force, removing air in the mixture faster, making the concrete stronger, with a blemish-free glass-like surface finish, eliminating pumping action and poor surface finish obtained by standard reciprocating piston vibrators. Both units are field repairable and not throw-aways like piston vibrators.

### **ELECTRIC MODEL USP-900**

115 VOLT 4 AMPS  
FORCE: 900 LBS.  
WEIGHT: 18 LBS.  
FREQUENCY: 9000 RPM



# STEEL FORMS CLAMP-ON BRACKETS

(86% VIBRATION TRANSFER)

## MODEL US-1600 Electric with UC-2 Clamp-on Bracket

(See page 16 for technical data.)

115 volt plug-in  
or use with  
field-generator

High frequency  
9000 VPM

Welded steel  
construction for  
durability

Hardened cup  
point set screws

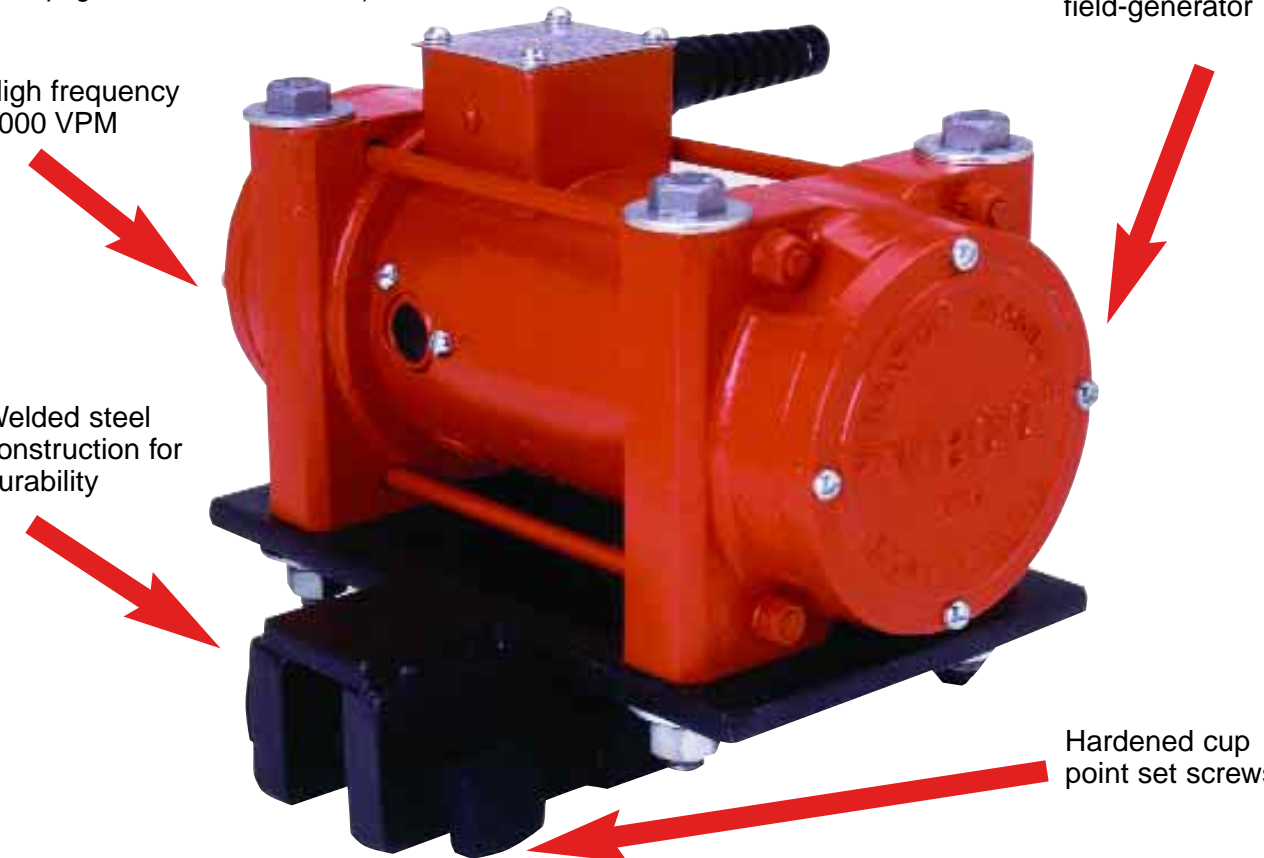

**Model 2P-450** electric with clamp-on (VMC-4). See page 16 for technical data.

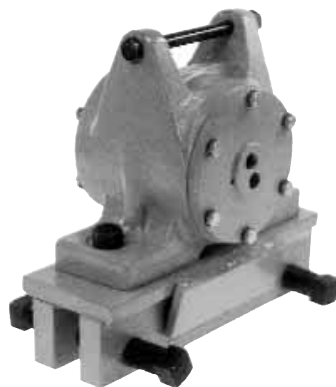

**Model SVRFS** pneumatic high force speed vibrator with SVC-4 bracket. See page 14 for technical data.

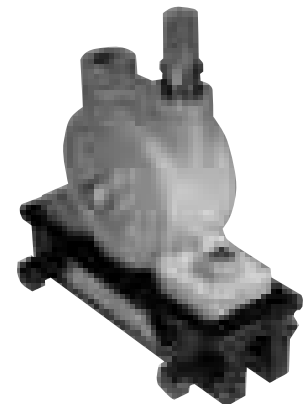

**Model BVS-570** pneumatic turbine (silent) with BVC-1 clamp-on bracket. See page 14 for technical data.

Clamp-on brackets eliminate welding or form preparation. They clamp on easily and quickly to any rib, flange, angle, or plate found on most forms. Vibration force can easily be applied where it is needed the most. Ideal for test pours to determine vibration force and position for best results. Knurled and hardened steel bolts fix bracket securely to form.

# WOOD FORM BRACKETS

(85% VIBRATION TRANSFER)

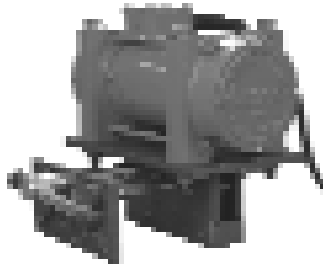

2P-200 Electric & VMF-2 Bracket.  
(See page 16 for technical data.)

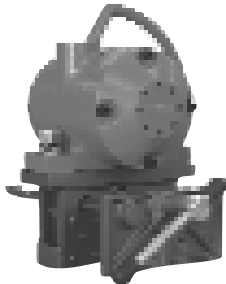

SVRFS-4000 & CCF-2000  
Turbine Air & CCF-1  
Bracket. (See page 12-14 for  
technical data.)

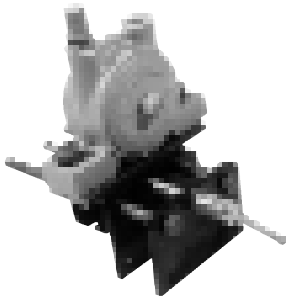

BVS or VS-510 Pneumatic  
on BVF-21 bracket. (See  
page 12-14 for technical  
data.)

Wood Form  
Bracket

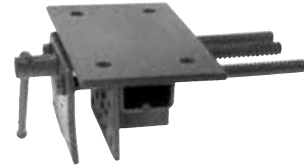

**US-900  
Electric on  
USF-2  
Bracket**

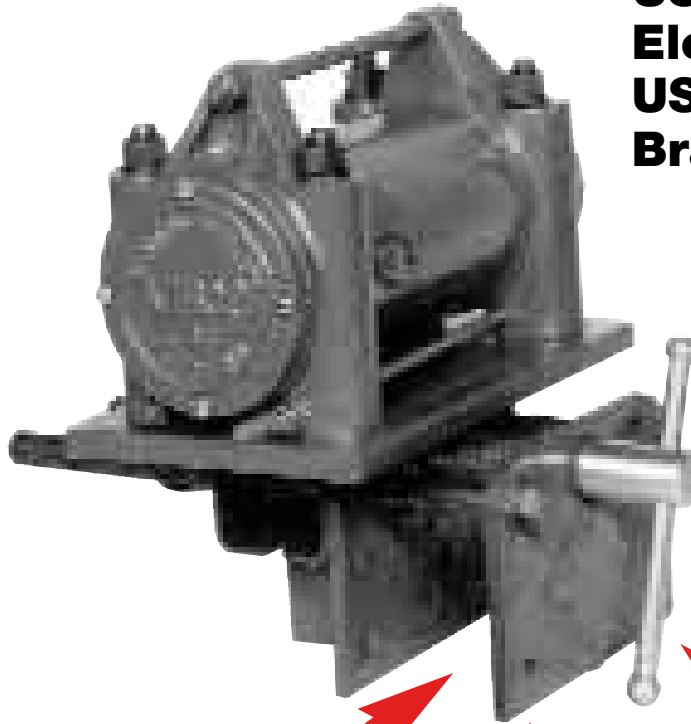

VIBCO Exclusive  
"Grip-Tight" vise

Quick action  
lock handle

Nail or Bolt Holes for  
Additional Security

## TO ATTACH A WOOD FORM BRACKET TO A STEEL FORM BOLT WOOD PIECES TO STEEL STIFFENER

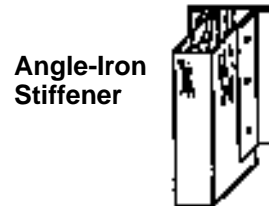
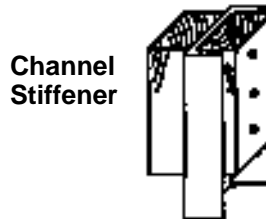
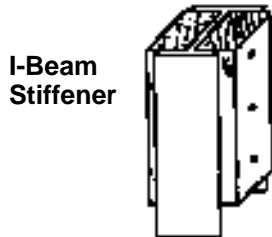

VIBCO'S wood form brackets are especially popular for pour-on-the-job work for columns, walls, fireproofing, etc., where wooden forms are used and architectural surface finish is required. Costly touching up and patching work are virtually eliminated. The vise with a jaw-span of 6" attaches securely to any whaler or support beam. **NOTE:** for wood forms with steel supports – consult VIBCO.

# Mounting Brackets

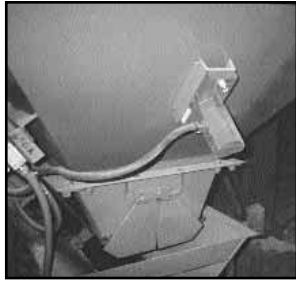

Weigh Batcher with Model 55-1-1/2 Piston



Septic Tank with US-900 & Wedge Bracket

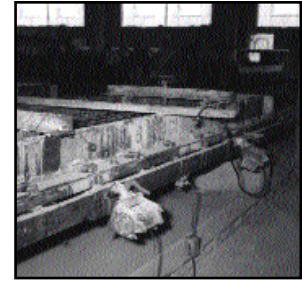

US-900 with Wedge Bracket on precast mold

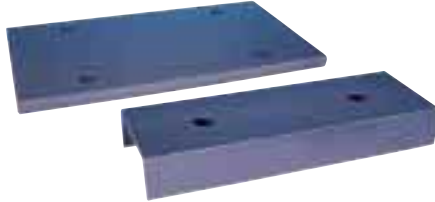

Mounting Plates & Channels



UWF-3 Heavy Duty Wedge Bracket



UWF-1 - Female Bracket for Wedge Form Bracket



Burial Vault — US 450T with Pin Bracket

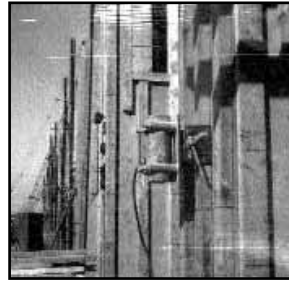

US-900 with wooden form clamp on column

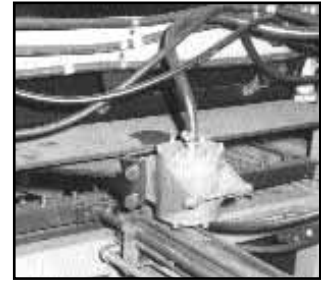

SVR-5500 with Shoe Bracket casting panels



Pin-Bracket with UPF-Female

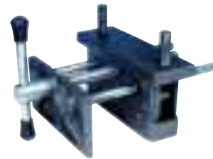

Wood-Form Bracket

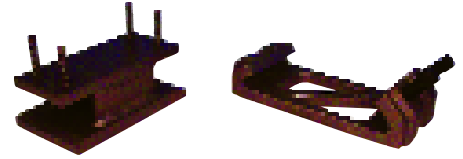

Adapter Bracket-For-SB Shoe Bracket



SVRLS-5500 on precast form



Electrical 2P-450 on Railroad Car Wedge

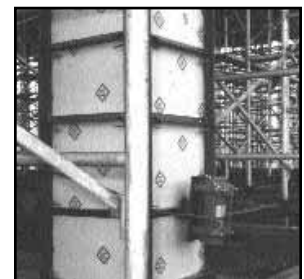

US-1600 with "Clamp-On" bracket on wooden form with steel reinforcing



Lug-Bracket - LC-1    Lug-Bracket - LC-2

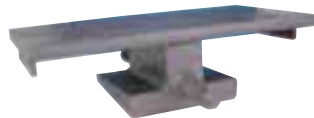

Rail-Road Car Wedge Bracket



Clamp-On Bracket

# Mounting Brackets

## STANDARD

Model	Mounting Bracket	Clamp Block	Car Shaker & Form Bracket Clamp-On Bracket	Car Shaker Wedge Bracket	Adapter Plate Form & Bin SB-Shoe Bracket	Wedge Type Form Bracket UWF-Female	Pin Form Bracket UPF-Female	Wooden Form Bracket
2P-75	VMM-11 (2)		VMC-81 (8)					
2P-100	VMM-111 (2)		VMC-82 (8)					
2P-150	VMM-12 (2)		VMC-83 (8)					
2P-200, 4P-350, 2P-450, 4P-700*	VMM-2 (7)		VMC-2 (18)	VMW-2 (16)	VMH-2 (7)			VMF-2 (18)
4P-1000*, 1 ph	VMM-4 (8)		VMC-4 (20)	VMW-4 (18)	VMH-4 (10)			VMF-4 (20)
6P-300*, 6P-500* 3 ph	VMM-3 (8)		VMC-3 (20)	VMW-3 (18)	VMH-3 (10)			VMF-3 (20)
2P-800 1 ph	VMM-61 (10)		VMC-61 (22)	VMW-61 (20)	VMH-61 (10)			
3 ph	VMM-5 (9)		VMC-4 (22)	VMW-5 (20)	VMH-5 (10)			
2P-1700 3 ph	VMM-6 (10)		VMC-6 (22)					
4P-1400 3 ph	VMM-6 (10)		VMC-6 (22)					
2P-2500,-3500,-4500 3 ph	VMM-7 (11)		VMC-7 (24)					
4P-2000 3 ph	VMM-6 (10)		VMC-6 (22)					
6P-1000 3 ph	VMM-6 (10)		VMC-6 (22)					
8P-500 3 ph	VMM-6 (10)		VMC-6 (22)					
2P-5500, 4P-3000 & 5000	VMM-8 (16)							
6P-1500 & 2500	VMM-8 (16)							
8P-750 & 1200	VMM-8 (16)							
SPR, SPRT-20, 21, 40, 60 & 80	SPM-1 (2) SPM-2 (3)	C-2 (3) C-2 (3)						
SPWT	SPWM (3)		SPWC (8)					
SCR-100, US-100 & DC-100	UM-1 (2)	C-2 (3)						
SCR-200, US-450 DC-450	UM-2 (4)	C-4 (4)			UA-1 (5)	UW-4* (8)	UW-1 (5)	
SCR-350, US-700, DC-700	UM-7	C-4				UW-5		
SCR-500	SCRM-2 (8)		SCRC-2 (20)	SCRW-2 (18)	SCRA-2 (10)			SCRF-2 (20)
SCR-1000	SCRM-1 (8)		SCRC-1 (20)	SCRW-1 (18)	SCRA-1 (10)			SCRF-1 (20)
SFC	SFCM (4)	C-4 (4)			SFCH (5)			
FC	FCM-1 (5)		FBB-1 (15)		FCH-1 (7)	UW-2* (8)		
US-900, DC-900	UM-3 (6)		UC-1 (15)		UA-2 (7)	UW-3* (8)		USF-2 (15)
US-1600, DC-1600	UM-4 (6)		UC-2 (16)		UA-3 (7)			USF-3 (15)
BB, BBS, FBS		C-1						
B, BV, BVS-130	BVM-1	C-2						
B, BV, BVS-190	BVM-2	C-2						
B, BV, BVS-250	BVM-3	C-2				BVT-4	BVP-5	
B, BV, BVS-320	BVM-4	C-3			BVH-4	BVT-3	BVP-4	BVF-4
B, BV, BVS-380	BVM-5	C-4			BVH-3	BVT-2	BVP-3	BVF-3
BVS-440/510	BVM-6	C-4	BVC-3		BVH-2	BVT-21	BVP-2	BVF-2
BVS-510F	BCM-61		BVC-2		BVH-21	BVT-1	BVP-21	BVF-21
BVS-570	BVM-7	C-4	BVC-1	BVW-1	BVH-1		BVP-1	BVF-1
V, VS-130	VSM-1	C-2				VST-3		
VS-190	VSM-2	C-2				VST-2	VSP-3	
VS-250	VSM-3	C-2				VST-2	VSP-2	VSF-2
VS-320, V-320	VSM-3	C-3			VH-1	VST-1	VSP-1	VSF-1
VS-380, V-380	VSM-4	C-4			VH-2	VST-4		VSF-3
VS-510	VSM-5		VC-1		VH-3	CCW-2		
CCF-2000, -4000	CCM-3		CCFC-3	CCFW-3	CCFH-3	CCW-3		
CCF-5000, -7000	CCM-1		CCFC-1	CCFW-1	CCFH-1			
CCL-5000, -7000			CCFC-2	CCFW-2	CCFH-2	SVH-1		
SVR-4000	SVM-1		SVC-1		SVA-1	SVH-2	SVP-1	SVF-1
SVR-5500			SVC-2	SVW-2				
SVRF-5500	SVM-2		SVC-4	SVW-4				
SVRL, SVRLS-5500, 6500, 8000			CCFC-2	SVW-2	CCFH-1			
SVR-8000	SVM-2		SVC-3	SVW-3				
PF, HF-800, -1200, -1500	PFM-1		PFC-1	PFW-1	SVA-6			
PF, HF-3000	PFM-2		PFC-2	PFW-2	PFA-1			

**DID YOU KNOW?**

VIBCO will design custom brackets to fit your needs. Just call 800-633-0032 to speak with an engineer today!



**DID YOU KNOW?**

VIBCO offers a wide selection of manuals available at [www.vibco.com](http://www.vibco.com). To receive our Quick Reference Manual or Full Detail Manual whenever you need it, please



( ) INDICATES WEIGHT IN LBS.  
\*USE 1 PHASE BRACKETS FOR BOTH 1 & 3 PHASE UNITS.

# PNEUMATIC VIBRATORS

## Most Commonly Used

### Permanently Mounted or with Bracketry for Concrete

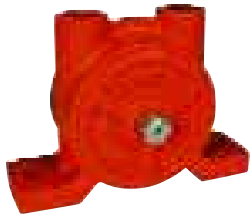

#### ROLLER VIBRATORS

BS-160, -380, -570

#### TURBINE VIBRATORS



CCF-2000, -5000

VS & BVS

#### HIGH FREQUENCY VIBRATORS



SVRFS-4000



SVRFS-5500



SVR-4000

#### HYDRAULIC VIBRATORS



SVRS-5500



HF-3000

There are a number of pneumatic units used in the concrete field. The ones listed here are the most common. They will all give satisfactory results but it is wise to recognize the advantages and limitations of each model.

**Roller Vibrators Model BS** with one moving part, a roller spinning free inside the housing. The preferred unit hand held or attached to small statuettes or the like forms, will make the stiffest mixes liquefy and flow, eliminating air entrapment. These units need lubricated air. Air consumption quite a bit higher than the turbines, speeds up to 11-12000 VPM, noise level 80-90 dB, force to 3000 lbs. Recommended pressure up to 80 PSI.

**Turbine Models VS & BVS** consist of a turbine wheel spinning on bearings attached to the shaft. The only ones not needing lubrication, they have the lowest dB reading 72-78 which is no more noise than an electric motor. They also have the lowest air consumption. Speed on the smaller units 7-8000, on the larger ones 5-6000, force up to 5000 lbs., recommended pressure up to 80 PSI.

**Model SVR's** the real workhorses of the pneumatic line. These vane roller units are bearingless with only two moving parts, a delrin vane and a rotor. They need a continuous lubricated air flow. These units are both the high force, up to 8000 lbs., and the high frequency units, up to 12000 VPM, preferred on the large concrete job for fast pour of the stiffest mixes, fast consolidation for optimum strength and architectural surface finish. Forces from 4000 to 8000 lbs. Frequencies from 9500 to 12000 VPM. Special units can be made for up to 16000 VPM. The most common ones are the lug type, see page 6 & 7.

#### Two models available: SILENT and Conventional

**A.** The conventional models with a dB reading of 95-100 are the low cost models. Due to the noise level of conventional models the silent versions may be a better choice.

**B.** Silent Models, the SVRS line, have a dB reading of 80-85 (within the OSHA limits). These patented units channel the air throughout the unit in such a way it eliminates much of the noise created in the conventional units. Force and speed matches the conventional units size for size.

**VIBCO's** patented SVR's have some definite advantages over other makes, such as:

- **VIBCO's "START EVERY TIME"**
- **VIBCO's** patented air saver chamber saves air- other units must exhaust all air before starting a cycle
- **VIBCO's** patented wear plates eliminate costly end cover wear which can create sluggish operation, excessive air consumption, and costly down time
- **VIBCO's** vibrators are made in the U.S.A.

#### HYDRAULIC MODELS

The hydraulic model HF-3000 operates on pressures up to 1500 PSI and creates 3000 lbs. of force at 7000 VPM.



# TECHNICAL DATA

MODEL	Weight		80 PSI		Force		dB*
	lbs.	kg.	Speed VPM*	CFM	lbs.	N	
<b>TURBINE VIBRATORS</b>							
VS-320	6.5	2.9	6800	11	600	2669	69
VS-380	11.5	5.2	5200	17	725	3226	72
BVS-380	13	5.8	5000	18	670	2981	74
BVS-510	16	7.3	4500	21	900	4004	77
BVS-570	23	10.4	4000	26	1050	4671	83
CCF-2000	23	10.5	6000	40	2000	8998	78
CCF-4000	23	10.5	6000	40	4000	17996	78A
CCF-5000	48	21.8	6000	50	5000	22245	75
<b>ROLLER VIBRATORS</b>							
BS-160	3	1.4	14500	10	300	1335	83
BS-380	13	5.9	10000	21	1450	6450	85
BS-570	25	11.4	10500	46	3000	13347	88
<b>HIGH FREQUENCY VIBRATORS</b>							
SVR-4000	23	10.4	11500	40	3600	16000	90
SVRFS-4000	23	10.4	11500	40	3600	16000	78
SVRF-5500	37	16.8	9000	56	4950	22000	98
SVRFS-5500	40	18	9000	56	4950	22000	82
SVR(S)-5500	40	18	9000	56	4950	22000	82
<b>HYDRAULIC VIBRATORS</b>							
			<b>1000PSI</b>	<b>GAL/MIN</b>			
HF-3000	39	17.7	7000	6	3000	13347	76

\*Frequency and Air Consumption will vary with load. \*\*dB @ 3' (1 meter) on A scale  
N = Centrifugal Force in Newton

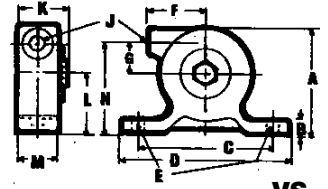

**VS**

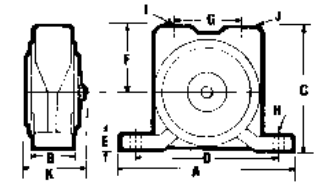

**BS & BVS**

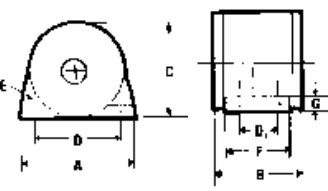

**SVR-4000**

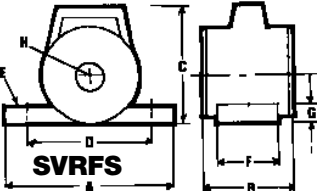

**SVRFS**

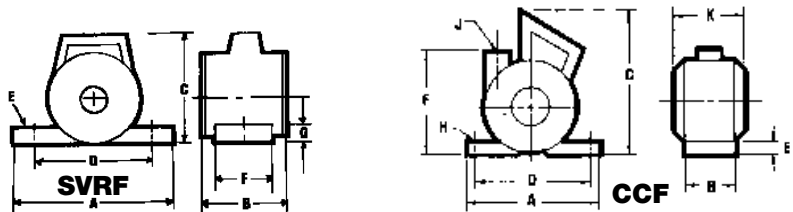

**CCF**

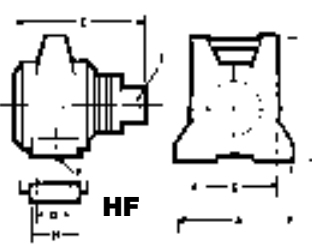

**HF**

## DIMENSIONS

MODEL	A inch/mm	B inch/mm	C** inch/mm	D inch/mm	E inch/mm	F inch/mm	G inch/mm	H inch/mm	I inch/mm	J inch/mm	K inch/mm	L inch/mm	M inch/mm
VS-320	4 <sup>5</sup> / <sub>8</sub> 117	3/4 19	4 102	5 <sup>9</sup> / <sub>16</sub> 135	1/2 12	2 <sup>1</sup> / <sub>4</sub> 57	1 <sup>1</sup> / <sub>8</sub> 29	4 <sup>1</sup> / <sub>8</sub> 105	-	3/8 - NPT	4 102	2 <sup>3</sup> / <sub>4</sub> 70	1 <sup>1</sup> / <sub>2</sub> 38
VS-380	4 <sup>7</sup> / <sub>8</sub> 124	1 25	5 <sup>1</sup> / <sub>2</sub> 140 1 <sup>1</sup> / <sub>4</sub> 32	6 <sup>3</sup> / <sub>8</sub> 168	3/8 10	2 <sup>7</sup> / <sub>8</sub> 73	1 <sup>1</sup> / <sub>2</sub> 38	4 102	-	3/8 - NPT	4 <sup>3</sup> / <sub>8</sub> 111	2 <sup>3</sup> / <sub>8</sub> 60	2 <sup>1</sup> / <sub>8</sub> 54
BVS-380	7 <sup>1</sup> / <sub>8</sub> 200	1 <sup>7</sup> / <sub>8</sub> 48	5 <sup>7</sup> / <sub>16</sub> 138	6 152	1 <sup>1</sup> / <sub>8</sub> 29	-	2 <sup>7</sup> / <sub>8</sub> 73	5 <sup>1</sup> / <sub>8</sub> 16	3/8 - NPT	1/2 - NPT	4 <sup>5</sup> / <sub>8</sub> 117	-	-
BVS-510	8 <sup>3</sup> / <sub>16</sub> 224	2 <sup>3</sup> / <sub>16</sub> 56	5 <sup>3</sup> / <sub>4</sub> 146	7 178	1 <sup>1</sup> / <sub>4</sub> 32	-	3 <sup>1</sup> / <sub>8</sub> 79	5 <sup>1</sup> / <sub>8</sub> 16	1/2 - NPT	3/4 - NPT	4 <sup>3</sup> / <sub>4</sub> 121	-	-
BVS-570	10 <sup>1</sup> / <sub>16</sub> 256	2 <sup>7</sup> / <sub>8</sub> 73	7 178	8 203	3/4 19	-	3 <sup>3</sup> / <sub>16</sub> 97	3/4 19	3/4 - NPT	1 - NPT	5 <sup>3</sup> / <sub>8</sub> 137	-	-
BS-160	5 <sup>1</sup> / <sub>2</sub> 140	1 <sup>1</sup> / <sub>4</sub> 32	3 <sup>5</sup> / <sub>8</sub> 92	4 102	9/16 14	2 51	1 <sup>13</sup> / <sub>16</sub> 46	3/8 10	1/4 - NPT	3/8 - NPT	1 <sup>9</sup> / <sub>16</sub> 40	-	-
BS-380	7 <sup>1</sup> / <sub>8</sub> 200	1 <sup>7</sup> / <sub>8</sub> 48	5 <sup>7</sup> / <sub>16</sub> 138	6 152	1 <sup>1</sup> / <sub>8</sub> 29	-	5 <sup>1</sup> / <sub>8</sub> 16	2 <sup>7</sup> / <sub>8</sub> 73	3/8 - NPT	1/2 - NPT	4 <sup>5</sup> / <sub>8</sub> 117	-	-
BVS-570	10 <sup>1</sup> / <sub>16</sub> 256	2 <sup>7</sup> / <sub>8</sub> 73	7 178	8 203	3/4 19	-	3/4 19	3 <sup>3</sup> / <sub>16</sub> 97	3/4 - NPT	1 - NPT	5 <sup>3</sup> / <sub>8</sub> 137	-	-
CCF-2000&4000	7 <sup>5</sup> / <sub>8</sub> 194	2 51	7 <sup>3</sup> / <sub>8</sub> 187	5 <sup>9</sup> / <sub>16</sub> 151	3/4 19	5 <sup>7</sup> / <sub>16</sub> 138	-	9/16 14	-	3/4 - NPT	7 <sup>3</sup> / <sub>4</sub> 197	-	-
CCF-5000&7000	10 <sup>1</sup> / <sub>16</sub> 256	3 76	9 229	8 203	1 25	6 153	-	3/4 19	-	1 - NPT	8 <sup>1</sup> / <sub>2</sub> 216	-	-
SVRFS-4000	7 <sup>5</sup> / <sub>8</sub> 194	7 <sup>3</sup> / <sub>4</sub> 197	7 <sup>3</sup> / <sub>8</sub> 187	6 152	9/16 14	2 51	3/4 19	3/4 19	-	-	-	-	-
SVRFS-5500	10 <sup>1</sup> / <sub>8</sub> 257	8 <sup>5</sup> / <sub>8</sub> 219	8 <sup>1</sup> / <sub>8</sub> 206	7 <sup>3</sup> / <sub>4</sub> 197	1 <sup>1</sup> / <sub>16</sub> 18	3 <sup>1</sup> / <sub>4</sub> 83	1 <sup>1</sup> / <sub>8</sub> 29	3/4 19	-	-	-	-	-
SVRF-5500	10 <sup>1</sup> / <sub>4</sub> 260	5 <sup>7</sup> / <sub>8</sub> 149	8 <sup>1</sup> / <sub>8</sub> 206	8 203	3/4 19	3 <sup>1</sup> / <sub>4</sub> 83	-	-	-	-	-	-	-
SVR-4000	7 <sup>1</sup> / <sub>2</sub> 191	6 <sup>1</sup> / <sub>8</sub> 156	5 127	6 <sup>1</sup> / <sub>4</sub> 158	1/2 12	3 <sup>7</sup> / <sub>16</sub> 87	7/8 22	2 51	-	-	-	-	-
SVRS-5500	6 <sup>7</sup> / <sub>8</sub> 175	6 <sup>1</sup> / <sub>16</sub> 154	7 <sup>3</sup> / <sub>8</sub> 187	-	-	3 <sup>1</sup> / <sub>2</sub> 89	-	-	-	-	-	-	-
HF-3000	10 <sup>3</sup> / <sub>8</sub> 264	8 <sup>3</sup> / <sub>4</sub> 222	11 <sup>1</sup> / <sub>4</sub> 286	8 <sup>1</sup> / <sub>2</sub> 216	1/2 - NPT	3/4 19	-	3 76	-	-	-	-	-

NOTE: Dimensions and data subject to change without notice.

# ELECTRIC VIBRATORS

MOST COMMONLY USED - PERMANENTLY MOUNTED OR WITH BRACKETRY FOR CONCRETE

## HIGH FREQUENCY



US-100

US-900



US-450

US-1600

## HEAVY DUTY



2P-75  
2P-150



2P-200



2P-450  
2P-800



2P-1700, 2P-2500,  
2P-3500, 2P-4500  
2P-5500

## HIGH FREQUENCY

### PLUS FEATURES:

#### FOR PRODUCT

- Faster pouring
- Less cement
- Greater density
- Reduced cost
- Smoother finish
- Faster form removal

#### FOR VIBRATOR

- Totally enclosed
- High impact
- Up to 10,000 VPM
- Low cost
- Lightweight
- Adjustable

VIBCO US line units are all 115 volt, single phase, universal type motors with low ampere draw. They can be plugged into any light outlet or operated from field generators. All units are speed and force adjustable by rheostat or transformer. **The larger units, US-900 and 1600, also have adjustable eccentrics for obtaining even higher forces at same frequency.** VIBCO's US line is rated for intermittent operation (30 minutes of operation in an hour). Heavy duty construction, exclusive VIBCO double eccentric and unloaded shaft design assure trouble free operation and long life under rough use.

## HEAVY DUTY ELECTRIC

### PLUS FEATURES:

- Oversized electric motor for higher safety factor
- High heat resistant winding to take additional overload and heat
- Oversized bearings for longer life
- Infinitely adjustable eccentrics

VIBCO's noiseless, heavy duty electric vibrators are 3 phase and most models are also available in single phase. They are totally enclosed and rated for continuous duty, designed to take the toughest of service in the concrete field. The smaller units are excellent on small tables or screeds. The 2P-450 and 2P-800's are standard for many screed manufacturers. The 2P-1700 and 2P-2500 are typical vibrators for larger tables and vibrating stands. The 2P-3500 and 2P-4500 are standard for the concrete pipe manufacturer.

All VIBCO units are made in the U.S. after U.S. NEMA and ASTM standards. All spare parts readily available from VIBCO or your local distributor.

## TECHNICAL DATA

Model	1 Phase Amperes at Volt		3 Phase Amperes at Volt		Force Impact				dB**	Weight**	
	115/230	230/460	lbs.	N	lbs.	N	lbs.	N		lbs.	Kg.
<b>HIGH FREQUENCY</b>											
US-100	.65/-	-	Speed Adjustable To				100	445	78	4	2
US-450	3.0/-	-	Speed Adjustable To				450	2002	80	13	6
US-900	4.5/-	-	600	2669	900	4003	1100	4893	85	25	11
US-1600	5.0/-	-	1100	4893	1600	7117	1900	8451	85	30	14
<b>HEAVY DUTY</b>											
2P-75	.5/25	.25/25	50	222	75	334	100	445	60	12	5
2P-150	1.8/9	.6/3	130	578	175	778	250	1112	63	27/23	12/10
2P-200	3/1.5	1/5	180	801	325	1446	400	1779	62	35/32	16/15
2P-450	5/2.5	1.2/6	100	445	680	3025	1100	4893	64	56/48	25/22
2P-800	8/4	2/1	100	445	1000	4448	1750	7784	70	86/78	39/35
2P-1700	-	3/1.5	600	2669	1500	6672	2500	11120	72	90	41
2P-2500	-	5/2.5	500	2224	1650	7339	3000	13344	73	105	48
2P-3500	-	5/2.5	500	2224	1650	7339	3000	13344	75	105	48
2P-4500	-	5.5/2.8	2200	9786	3430	15257	5000	22240	76	110	50
2P-5500*	-	8/4	4500	20016	5500	24464	6500	28912	78	220	100

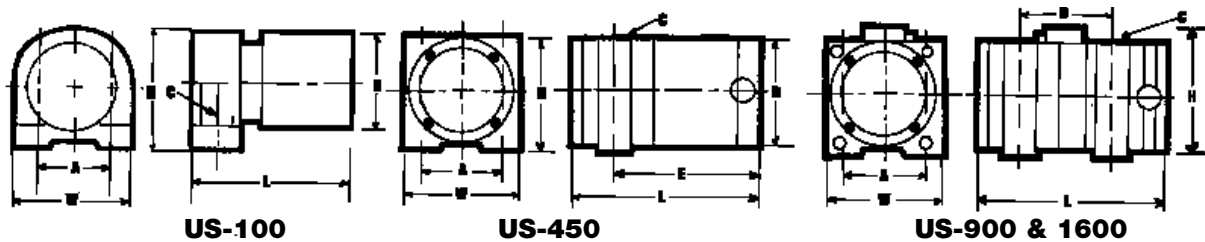

## DIMENSIONS HIGH FREQUENCY

Model	A		B		C		D		E		L		W		H	
US-100	5	127	-	-	3/8	10	4	102	5 1/2	140	6 3/4	171	6	152	4 1/4	108
US-450	3 1/2	89	-	-	1/2	12	4	102	6 1/2	165	8 1/4	210	4 7/8	124	4 1/8	105
US-900	3 1/2	89	6 7/8	175	1/2	12	4	102	-	-	11 1/8	283	4 7/8	124	6 1/4	160
US-1600	4 1/2	114	7	178	1/2	12	4 1/2	184	-	-	11 1/4	286	5 5/8	143	5 5/8	143

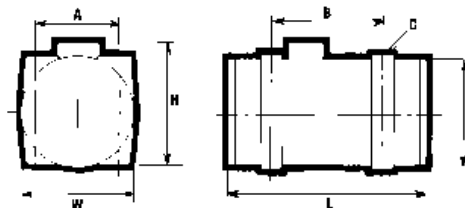

## DIMENSIONS HEAVY DUTY

Model	Phase	A		B		C		D		L		W		H	
2P-75	1	3	76	4 11/16	117	5/16	102	3 9/16	90	7 1/2	190	4 1/8	105	5	127
2P-150	1 & 3	3 1/2	89	7	178	1/2	102	4	102	11 3/16	284	4 7/8	124	6 1/4	160
2P-200	1 & 3	4 1/2	114	6 15/16	178	1/2	102	5 1/16	130	11 3/16	284	5 3/4	145	6 3/8	162
2P-450	1	5	127	8 3/8	210	5/8	184	6	152	13 1/2	343	6 1/2	165	7 3/8	187
2P-800	1	5 1/2	140	9 5/8	244	5/8	16	7	178	14 3/4	375	7 1/4	184	8 1/2	216
	3	5 1/2	140	8 5/8	215	5/8	16	7	178	13 1/2	343	7 1/4	184	8 1/2	216
2P-1700	3	5 1/2	140	10 13/16	275	5/8	16	7	178	16 1/2	420	7 1/4	184	8 1/2	216
2P-2500	3	5 1/2	140	11 5/8	291	5/8	16	7	178	17 3/8	441	7 1/4	184	8 1/2	216
2P-3500	3	5 1/2	140	11 5/8	291	5/8	16	7	178	17 3/8	441	7 1/4	184	8 1/2	216
2P-4500	3	5 1/2	140	11 5/8	275	5/8	16	7	178	18 7/8	480	7 1/4	184	8 1/2	216
2P-5500	3	7 1/8	200	12 13/16	325	1	25	8 7/8	225	22 1/4	565	10 1/4	267	10 1/2	267

NOTE: Dimensions and data subject to change without notice.

# GENERAL RULES

**DID YOU KNOW?**  
 VIBCO offers VMT hand held vibrators.  
 Call 800-633-0032 for more info,  
 or visit us at [www.vibco.com](http://www.vibco.com)



## I. CHOOSE ELECTRIC OR PNEUMATIC VIBRATORS

In the U.S., the most common vibrators are the pneumatic. They are easy to use, safer, lightweight, portable, simple to repair and cost less than electric.

The smaller, electric 115-volt plug-ins are popular, especially on small forms and on outside jobs where a generator is easier to use than large air compressors and air hoses.

Large 3 phase electric vibrators are primarily used on vibrating tables and large pipe forms where they are permanently mounted on the forms.

## II. PORTABLE OR PERMANENTLY MOUNTED, WHICH TO CHOOSE?

The permanently mounted vibrators will last longer "maintenance-wise", transmit vibration better, and release an operator for other duties.

The portable vibrators are very popular – one vibrator can be moved to different positions, used on different forms, and additional female brackets can be mounted in places where additional vibration is required. A host of different types of brackets are available from VIBCO to help with this type of application.

## III. WHICH MODEL AND SIZE VIBRATOR TO CHOOSE?

**A. First determine how much vibration force is needed** for the complete form. Add form weight to concrete weight with the following adjustments. It is important to know what slump concrete is used.

- For concrete with 0" slump or dry concrete, add 200% to the weight of form plus concrete **to get the vibration force needed.**
- For 1" to 2" slump, add 75% to form and concrete weight **to get total force needed.**
- For concrete with a 3" to 5" slump – standard for all over the road delivered concrete trucks – **use vibrator force same as the form plus concrete weight.**

**B. Placement of vibrators** - Vibration force travels in a 3' to 4' radius from the vibrator on steel forms. It dissipates rapidly thereafter. Place vibrators in a pattern so that vibration forces overlap slightly. The corners are usually very stiff, so place vibrators close to the corners on a 2.5' to 3' radius.

**C. Penetration** - Vibration force penetrates concrete up to 6" to 8" depending on slump. Concrete is thicker than 8", vibrators (staggered) are needed on both sides of the form.

**D. How many vibrators are needed?** Make a layout of your form and place vibrators on 6' to 8' centers (vibration travels a 3' to 4' radius). On corners, place vibrators on 5' to 6' center (2.5 to 3' radius). Once you have laid out the vibrator pattern and you know how many you need, divide the numbers of vibrators into the total weight of form and concrete (see paragraph one). The sum is the VIBRATION FORCE needed on the vibrator.

**E. Which vibrator to choose?** VIBCO has over 300 vibrator models, pneumatic, electric and hydraulic, to choose from. VIBCO has been in business since 1962 (over 40 years), and certain vibrators have proven to be the best solution, best value and require the least maintenance for concrete applications. Below is a list of the most commonly used vibrators:

### SMALL TO MEDIUM SIZE FORMS

ELECTRIC	VOLTAGE	PAGES	FORCE OUTPUT
US-450	115V	16 & 17	450 lbs.
US-700	115V	16 & 17	700 lbs.
US-900	115V	16 & 17	900 lbs.
USL-900	115V	6 & 7	1100 lbs.
US-1600	115V	16 & 17	1600 lbs.
USL-1600	115V	6 & 7	1800 lbs.
2PL-900	115V	6 & 7	900 lbs.
2PL-1600	115V	6 & 7	1600 lbs.
PNEUMATIC	PAGE	FORCE OUTPUT	
VS-320HS, V-320HS	14 & 15	600 lbs.	
VS-380HS, V-380HS	14 & 15	725 lbs.	
VS-510HS	14 & 15	900 lbs.	
CCF-2000, CCL-2000, CCW-2000	14 & 15	2000 lbs.	

**DID YOU KNOW?**  
 VIBCO offers  
 immediate  
 service  
 either in  
 person or over  
 the phone  
 24 hours a day  
 7 days a week  
 Call 800-633-0032  
 or visit us at  
[www.vibco.com](http://www.vibco.com)



## MEDIUM TO LARGE FORMS

PNEUMATIC		PAGE	DECIBELS	FORCE OUTPUT
CCL-4000, CCF-4000, CCW-4000		6 & 7	78 dB	4000 lbs.
SVRLS, SVRFS, SVRWS-4000		6 & 7	78 dB	4000 lbs.
SVR-4000		6 & 7	82 dB	4000 lbs.
CCF, CCL-5000		14 & 15	78 dB	5000 lbs.
SVRFS, SVRLS-5500		14 & 15	98 dB	5000 lbs.
CCF, CCL-7000		14 & 15	78 dB	7000 lbs.
ELECTRIC	PHASE	PAGE	FORCE OUTPUT	
2P-800	1 & 3 phase	16 & 17	1700 lbs.	
2P-1700	3 phase	16 & 17	2500 lbs.	
2P-2500	3 phase	16 & 17	3500 lbs.	
2P-3500	3 phase	16 & 17	4500 lbs.	
2P-4500	3 phase	16 & 17	5500 lbs.	
2P-5500	3 phase	16 & 17	6800 lbs.	

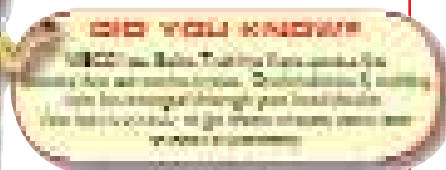

The 115-volt “plug-in” electric models US and USL are popular for small to medium forms when compressed air is not always available or on job sites where generators can be used.

The larger 3 phase models – 2P-800 and up – are used for permanent mounting on concrete pipe forms and vibrating tables.

The pneumatic vibrators are by far the most popular ones, they are low cost, lightweight, easy to mount to any bracketry, and easily repairable by the mechanic on the job site.

The pneumatic turbine lines VS, CCF, CCL and CCW are the most popular for the small to medium size forms, because of their noiseless operation, noise as low as 72dB at high frequency and light weight . They are pre-lubricated for life so no lubrication is necessary.

### FOR THE LARGER FORMS

The larger CCF, CCL-4000, -5000, and -7000 are used for larger forms. They are quiet, high force, and no lubrication is required. These units are also excellent for self-consolidating concrete.

The SVR line of high frequency vibrators can produce as high as 15,000 VPM, which is ideal for obtaining a smooth architectural finish. The standard units have frequencies of 8,000 to 12,000 VPM for fast placement and producing strong, void-free finishes.

These units must be continually lubricated to maintain their speed and force output.

#### F. Vibration procedure and vibration time.

1. Vibration Procedure: Place vibrators to be used in their lowest position. It's a good idea to pre-mark the vibrator position. Do not start vibrators until the concrete reaches them or is no more than 6” above them.

**TIP:** If internal vibrators are used, do not start the external ones until the internals have stopped or moved to a higher position. The reason for this is, internal vibrators throw air bubbles away from the vibrator head against form side leaving air holes and pockets on the surface. External vibrators throw air bubbles into the mix, up and out, leaving surface against form smooth and blemish free.

2. How long to vibrate? Some experimentation on the customer's part is always necessary because the time you need to vibrate varies depending on concrete slump, additives, stiffness of form, vibrator force, etc.

*Do not start the lowest vibrator until the concrete reaches them or is no more than 6” above. The concrete stiffens the form and if vibrated earlier, the vibration might move the form, making it flex, promoting leaks and seepage.*

- a. If there is only one vibrator on the side of the form, keep it vibrating until the form is full and no more air bubbles are breaking on the top of the concrete and a glistening surface appears.
- b. If there are multiple vibrators per side, keep the lower vibrator running until the concrete pour reaches the higher vibrator – then stop the lower one, start the higher one and let it vibrate until the pour is complete and no more bubbles break on the surface of the concrete and a glistening surface appears.

#### G. Helpful hints and corrections after you strip the form (please see page 27 under septic tanks).

#### H. Additional Tips

1. Metal forms transmit vibration far more effectively than wood forms.
2. Always stiffen up forms to avoid distortion and flutter and for best vibration transmittal to concrete.
3. Rest forms on wood beams or rubber mats to avoid vibration transmittal to floor and surrounding forms, as well as for quiet operation and increased vibration amplitude and uniform compaction.
4. Vibration time depends on height and structure of form. Vibrators should be operated until a flat, glistening surface appears and no more air bubbles burst on the surface.
5. Concrete of proper consistency is not susceptible to over vibration and segregation. If segregating occurs, reduce slump, not vibration time and tighten form joint.

Our experience has been to see “under-vibration” rather than “over-vibration” due to too short vibration time or force, to get a homogenous, air-bubble-free mix.

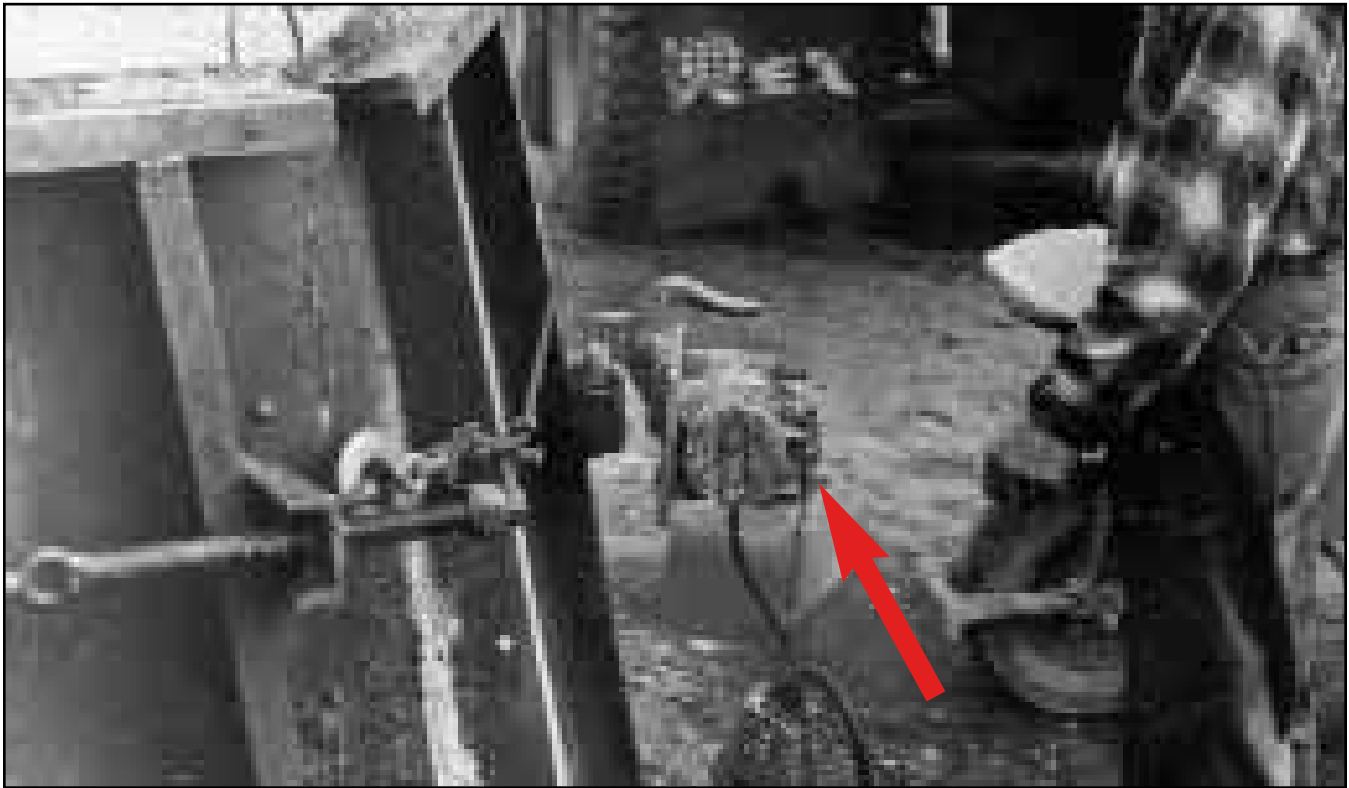

**Model US-900** electric 115 volt vibrator with UW-2 wedge bracket is attached to UWF female bracket welded to form side half way up. A second UWF bracket is welded to opposite side 1/2 way up form side. See below for vibrating procedure.

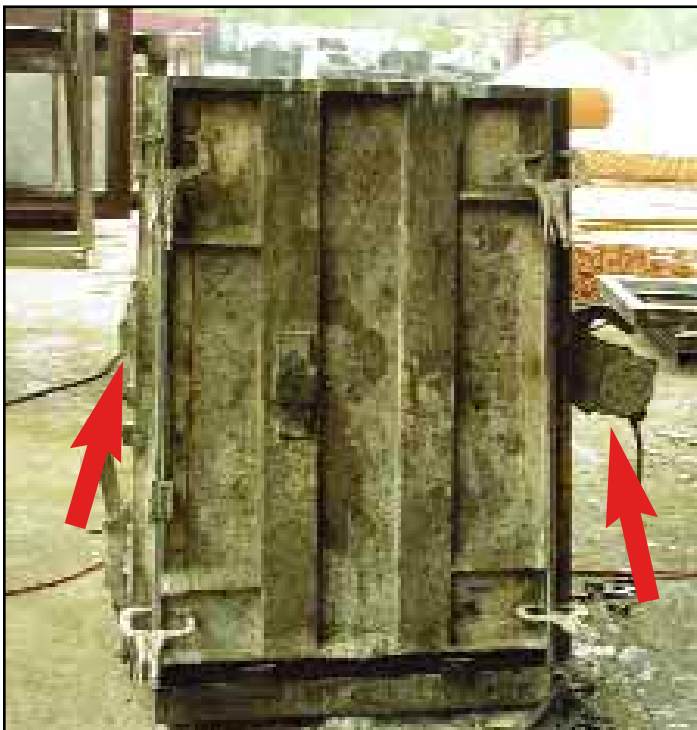

5' square manhole form uses **Model US-1600** 115 volt electric vibrator with wedge form bracket (page 5). Female vibrator bracket is mounted 1/2 way up on opposite sides. Vibrator is started when the concrete pour reaches it, and is left on until pour is complete. The vibrator is then moved to opposite side and started and kept running until no more air bubbles break on the surface and the surface has a glossy appearance.

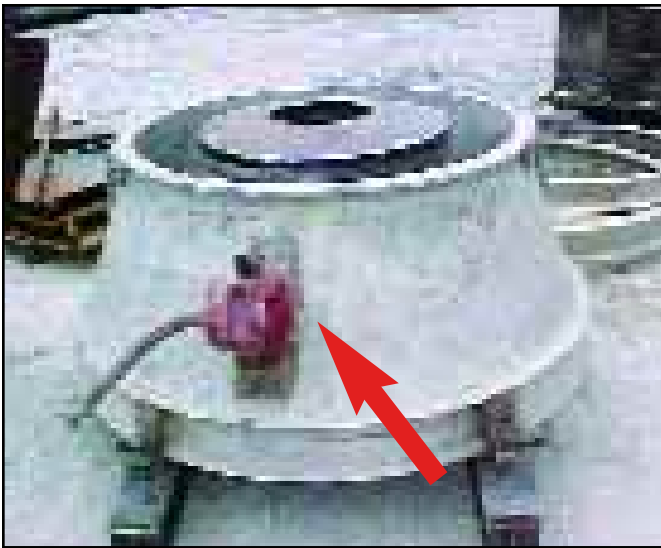

SVRL-4000 on precast manhole

**2 Model SVRL-4000's** on lug bracket (page 0) 3' high form. Vibrator placed 1/2 way up form side. Second vibrator directly opposite also 1/2 way up. Same vibrator moved from one side to the other started to vibrate when concrete reached vibrator. Continued to vibrate until form was full, then removed vibrator and put on opposite side. Kept vibrating until slick surface appears on top.



US-1600 on manhole

**2 Model US-1600's** on a 6' high form - one placed 2' from bottom, the other 180° apart and 2' from top. Lower vibrator starts running when concrete reaches it and continues to vibrate until pour reaches high vibrator. Stop bottom vibrator and move to high position and start to vibrate until pour complete and no more air bubbles break on surface and a glistening surface appears on top.



SVRL on manhole form

**2 Model SVRL's** on a 6' high form - one placed 2' from bottom, the other 180° apart and 2' from top. Lower vibrator starts running when concrete reaches it and continues to vibrate until pour reaches high vibrator. Stop bottom vibrator and move to high position and started to vibrate until pour complete and no more air bubbles break on surface and a glistening surface appears on top.

## SMALL PRE-CAST FORMS CONTINUED

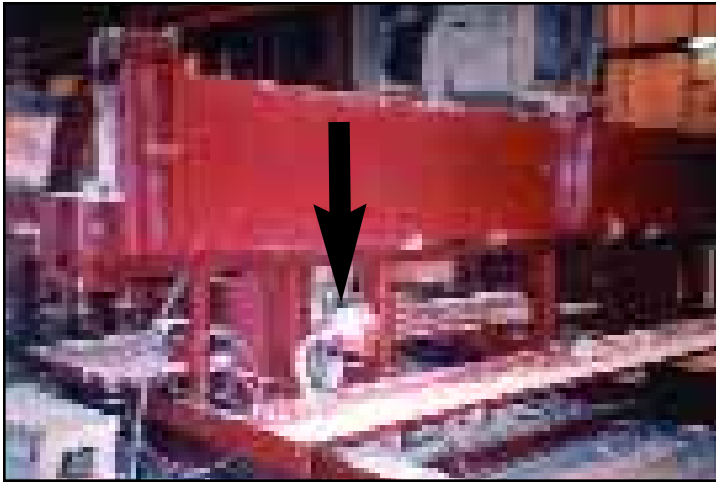

**LEFT:**  
**SVRLS-5500** MOUNTED ON LEG  
 OF LARGE FORM.  
 (vibrators and brackets page 6)

**PROBLEM:** Customer wanted to decrease pouring time and improve appearance of finished product.

**SOLUTION:** Two Model SVRLS-5500's were mounted on the front stiffener directly 180° opposite each other.

**CUSTOMER SAYS:** The pour time was drastically reduced. Previously two men used poker vibrators, now only one man was needed. Product came out beautiful without blemishes and customer was very happy.



**RIGHT:**  
 Large culvert form uses  
**SVRLS-5500** vibrators.  
 2' from ends,  
 6' center to check  
 (vibrators and  
 brackets page 6)

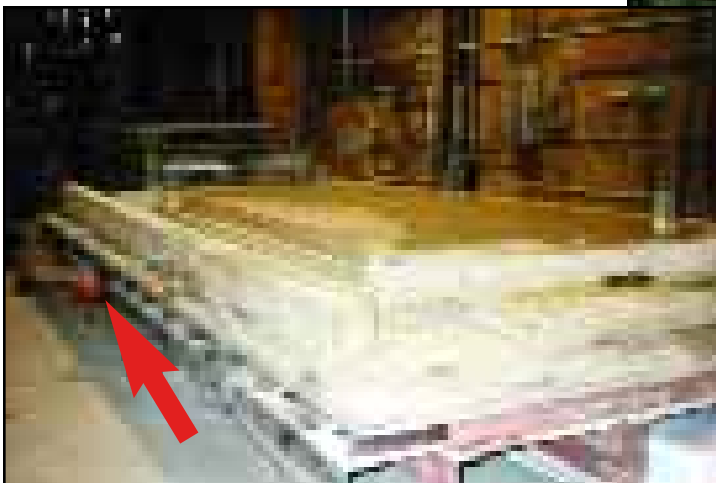
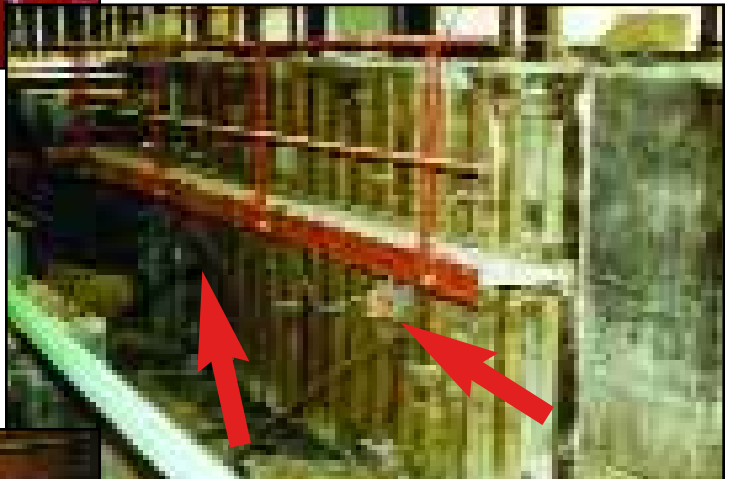

**LEFT:**  
 Large table with 2 **SVRL-5500**  
 vibrators used to cast concrete in all  
 types of wooden molds.  
 (vibrators and brackets page 6)



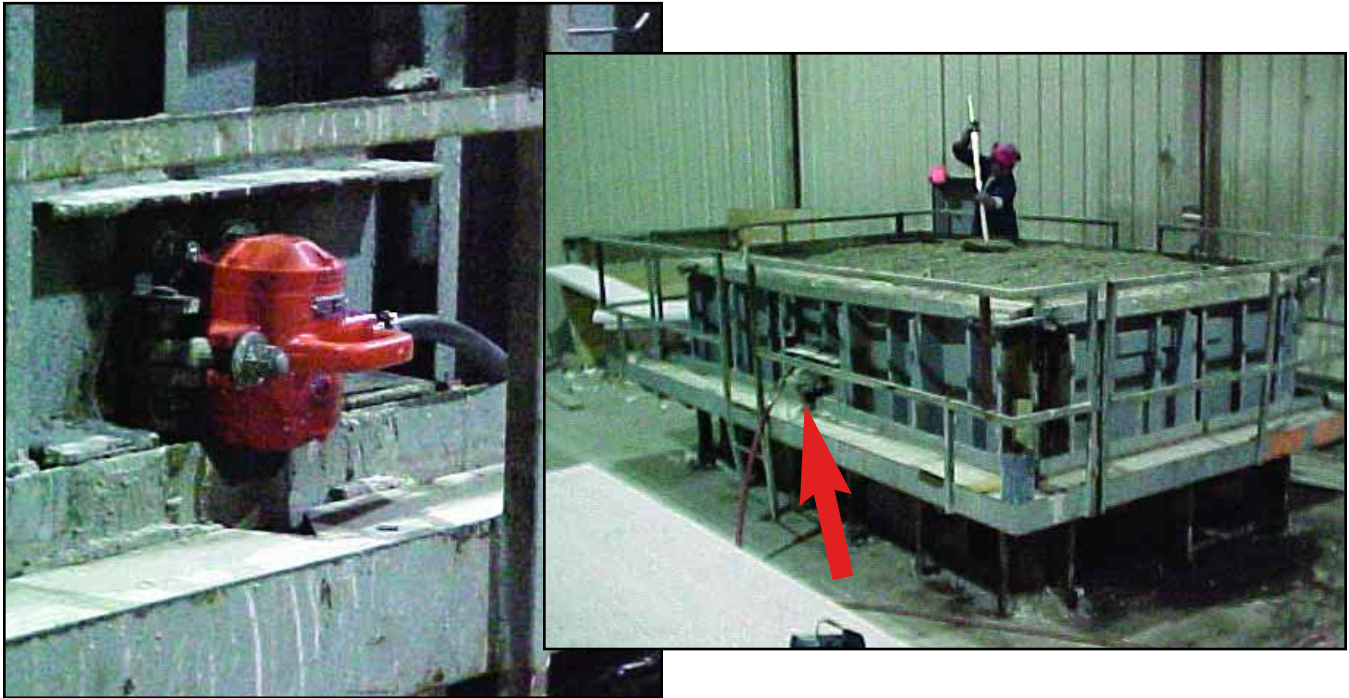

**Model CCL-7000** silent turbine vibrator is used on forms with “self consolidating concrete” for 5-10 seconds to improve the finish to an almost architectural one.



US-1600 on hog slot table

**Model 1600** electric vibrators with wedge brackets on hog-slot production form. The vibrators were used to slump down the concrete pile as it was dumped onto the form.

Two electric **Model US-1600** vibrators with clamp-on bracket were used on this 3 x 3 x 6' high manhole form.

US-1600 on box form





SVRL-5500 on large mold (2 units used.)



**ABOVE:**

**PROBLEM:** 54" high barrier form – how many vibrators are needed?

**FORM:** Steel form wood beams and rubber pads.

**WEIGHT:** Form plus concrete - 8000 lbs.

**CONCRETE:** 2" slump

Total force needed = for 2" slump add 75% = 14000 LBS.

Use 4 SVR-4000 pneumatic vibrators each 4000 lbs. Total 16000 lbs. force (page 14)

Two mounted close to bottom on one side – two opposite half-way up form side.



Two **Model SVRLS** pneumatic vibrators on lug brackets were mounted diametrically opposite on this box form.

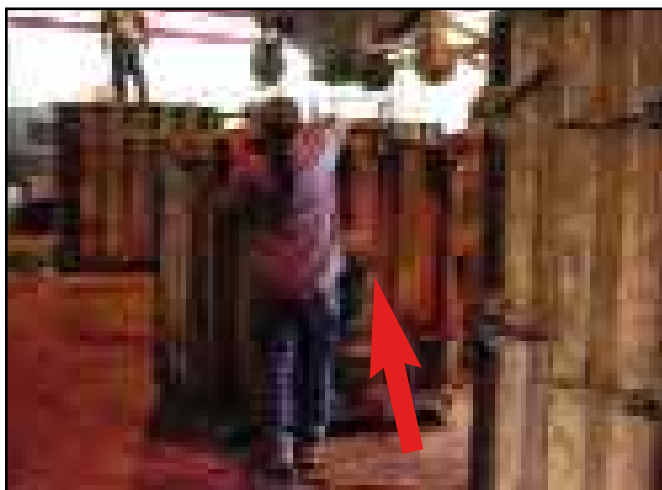

**LEFT:**

Two US-1600 electric vibrators were used on this manhole mounted just above centerline on opposite sides. Vibrators were turned on when concrete reached them and continued to run until form was filled and no more air bubbles burst on the top.

# LARGE PRE-CAST FORMS CONTINUED



**LEFT:**

24 **Model CCL-7000** lug type silent turbine pneumatic vibrators were mounted on both the inside core and outside walls of a precast building form.



**RIGHT:**

Two **Model SVRL-6500** high frequency pneumatic vibrators were installed opposite each other on form with an adjustable pallet.

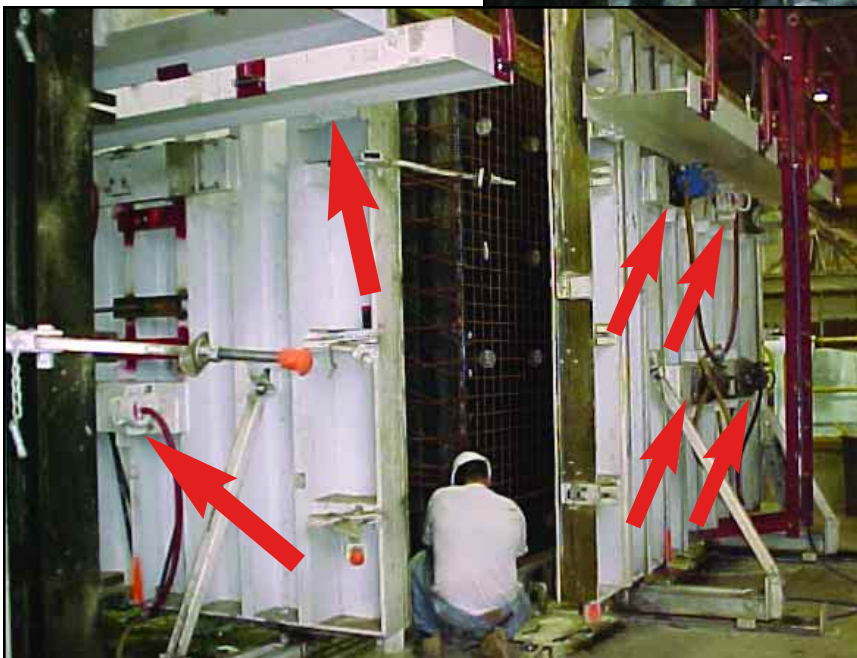

SVRLS on prison cell form



**DID YOU KNOW?**  
VIBCO offers free plant surveys!  
Call 800-633-0032 today!  
We will supply you with the right equipment!

**LEFT:**

12 **SVRL-6500** high frequency pneumatic vibrators were mounted to each of the long outside walls and 2 on the short end walls.

## VIBRATORS MOST COMMONLY USED ON SEPTIC TANKS & BURIAL VAULTS

**PORTABLE & ELECTRIC:** Model US-900 & US-1600 high frequency vibrators, up to 10,000 vibrations per minute. Easy 115 volt plug in, low amperage and can be plugged into any light outlet. US-900 is mounted on a wedge bracket model UW-2 (pages 2-5). The UWF female bracket is welded to the form (see mounting below). The US-1600 is mounted on a UW-3 wedge. The US-900 is used on standard septic tanks, US-1600 on larger ones.

**IMPORTANT NOTE:** High Frequency Electric Vibrators are intermittent duty units with a maximum "on" time per hour of 30 minutes. If vibration time extends beyond the duty time, use two units and leapfrog them from form to form.

The wedge brackets transfer vibration up to 90%. For 100% transfer use Model USL-900 & USL 1600 with lug bracket (see page 6 & 7). For Burial Vaults use Model USP-900 (page 9).

**PORTABLE PNEUMATIC:** For septic tanks use Model SVRWS-4000 Silent High Frequency Vibrator up to 11,000 VPM (page 3). This unit is recommended for the larger forms and CCW-2000 (page 3). Silent Pneumatic Vibrator is recommended for the smaller forms. CCW-2000 is prelubricated for life and the SVRWS-4000 needs to be lubricated from an oiler in the airline. For burial vaults use VSP-510 silent pneumatic turbine vibrator (see page 9).

**PERMANENTLY MOUNTED VIBRATORS:** Many concrete producers choose to mount the vibrator permanently on the forms to save time, lower labor cost, and reduce handling of the equipment and repair costs.

Suggested vibrators for permanent mountings are Electric Model US-900 for standard septic tanks and burial vaults. US-1600 in single phase or 2P-200 in 3 phase (page 16 & 17) or the pneumatic unit Model CCF-2000 for standard septic tanks and for the large ones Model SVRFS-4000 (page 14-15). For burial vaults use Model VSP-510 (page 9).

## HOW & WHERE TO MOUNT THE VIBRATORS

**QUESTION:** Why can't I mount the vibrator to the skin of the form?

**ANSWER:** When you put a vibrator directly on the skin of the form, you create several problems.

1. You create an "oil canning effect." The movement of the skin actually draws air in, producing air holes.
2. The vibration energy is not distributed over form side but is concentrated just around the vibrator. This concentrated force will create fatigue cracks in the form skin and the vibration may actually tear out a piece of the form around the vibrator. The concentrated vibration energy also may cause segregation where the vibrator is mounted.

The correct way to mount the vibrators is on a stiffener to distribute the vibration energy or force over a larger surface as well as to prevent the "oil canning effect," reducing the problem of fatigue cracks.

### SUGGESTION #1

Acceptable Mount:  
Mounting plate  
parallel to stiffener

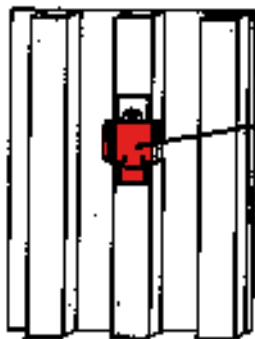

### SUGGESTION #2

Preferred Mount:  
Channel iron over  
stiffeners

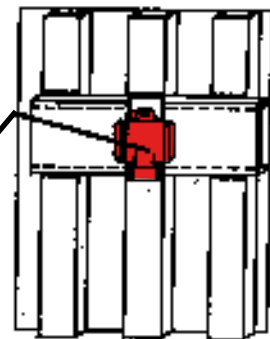

VIBRATOR

#2 preferred mount is better because:

1. An added stiffener is usually only tack welded to the skin of the form and if welds are not reinforced fatigue cracks may develop.
2. If you secure a channel iron over 3 stiffeners as in the preferred #2 mount, you are using stiffeners that are a rigid part of the form and the energy forces of the vibrator are used much more effectively.

# SEPTIC TANKS CONTINUED

## SEPTIC TANKS

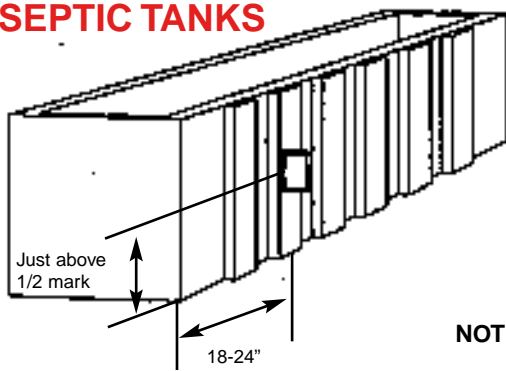

NOTE: 2nd vibrator bracket 180° opposite

## BURIAL VAULTS

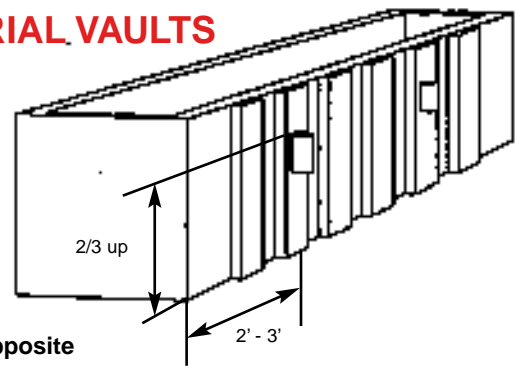

NOTE: 2nd vibrator directly opposite

**STANDARD MOUNTING**  
2 Vibrators or Bracket Positions

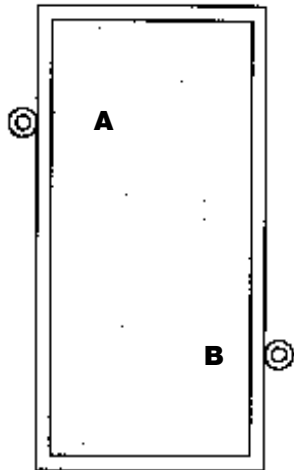

**STIFF MIX MOUNTING**  
4 Vibrators or Bracket Positions

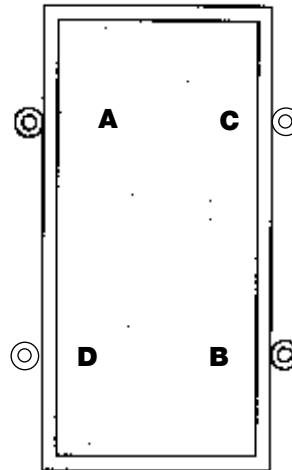

### TECHNICAL HINTS FOR VIBRATING SEPTIC TANKS AND BURIAL VAULTS

Some experimentation on the customer's part is always necessary because the end result is determined by the way the forms react to vibration transfer, the concrete mix, additives used, and the form oil. For casting septic tanks we recommend the use of two vibrators.

Start the pour as usual, and if a continuous and quick pour is planned, begin to vibrate when concrete is 6" above vibrator. If vibration is ample you should notice a leveling off of concrete and glossy surface and air bubbles rising to the surface. Continue vibrating for about a minute after pour is completed. If placement of concrete is intermittent then vibrate for 1 to 2 minutes more after each pour.

When the concrete has been thoroughly vibrated a glossy surface and few (if any) air bubbles bursting on the surface will appear.

### TROUBLESHOOTING AND CORRECTIONS AFTER YOU STRIP FORM.

1. Separation of aggregate (too long vibration time or too much water in mix).
2. Bleeding of cement and water (tighten seals in form or use less water).
3. Honeycomb (often from bleeding, but if not, increase vibration time. If honeycomb on lower surface, move one vibrator lower and tighten seals).
4. Small pinholes in finish (often difficult to determine cause). Usually from: too wet mix; air entering, or other additives; possibly from form oil, or boiling in of air from action of form where form wall is too flimsy and flexes too much, weld on stiffeners to form wall).
5. Larger pinholes – if all over, try reducing water content, vibrating longer after pour, adding additional vibrator, or re-vibration before initial set.



#### DID YOU KNOW?

Use VIBCO vibrators with all concrete casting to ensure the longest life for the form.

### BURIAL VAULTS

Model VSP-510 Rotary Piston Vibrator used on Burial Vault (page 9). Same wedge brackets and vibrators as on septic tanks can also be used. Wedge brackets give a 90-100% vibration transfer. Pin brackets 60-75%.



# SEPTIC TANKS, BURIAL VAULTS & CULVERTS CONTINUED



Burial Vault form with VSP-510 Rotary Piston Vibrator.



Model US-1600 permanently mounted on 5500 lb. mold.



Model US-450 on wedge-bracket for vibrating lid on burial vault form.



Silent pneumatic turbine model VS-510 on wedge bracket on well liner form.



Portable US-900 on UW-2 wedge bracket for multiple septic tank forms.



US-1600 with wedge on culvert form. (Notice a rubber sheet covers vibrator and protects it from concrete spill.)

**WEL TUV KUNNY**  
 VIBCO's #1 T-17 included support  
 Call 800-633-0032 or any time  
 (800) 633-0032





**3-Step Form using US-900 Electric with UW-2 Wedge Bracket.**

Concrete steps are generally poured either upside-down or straight up. Either way, our high frequency Model US-900 or US-1600 is the most frequently used electric vibrator. The SVRW-4000 or CCW-2000 (page 2-3) can be used if air vibrators are desired. They are placed on form stiffeners on the inside transmitting the vibration to the form side. Apply the same general rules for obtaining strong and smooth surfaces as for septic tanks.

Internal vibrators are used on many forms. The general disadvantages are that they tie up one man moving the vibrator around the form. They push air bubbles against the form side where they stick, leaving the surface pitted and unattractive to look at, sometimes leaving the customer believing the product is inferior. The external vibrators, by design, can be left running in the bracket, releasing the operator to do other work until the vibrator is turned off or moved. The vibration travels along the form side pushing the air bubbles away from it, up and out of the mix, leaving a void-free, smooth and attractive surface. For an especially smooth surface, sometimes a minute or so of vibration just before the concrete sets (after vibration) gives excellent results.

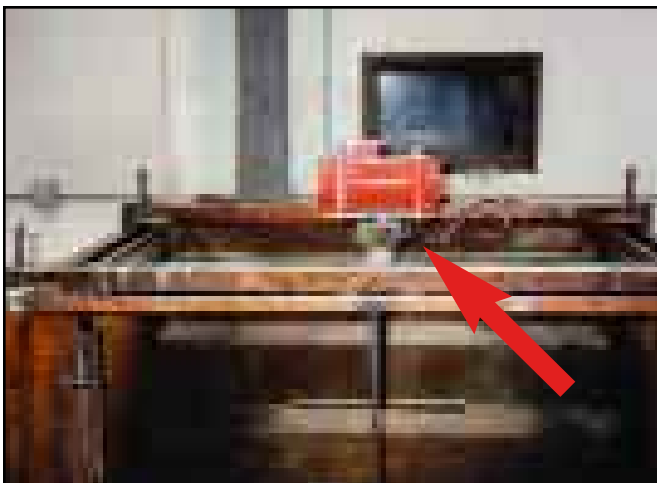

One Model 2P-200 115 Volt vibrator handles complete step form. 2P-200 attached to adapter plate & shoe bracket welded to form stiffeners (page 8).



4-Step Form using US-1600 Electric with UW-5 bracket (page 2).

**ORNAMENTAL CONCRETE PRODUCERS**

**USE V-130 BALL VIBRATOR WITH SPECIAL VISE-GRIP CLAMP VC-130**

**PROBLEM:** Ornamental Concrete Manufacturer had problems vibrating tall pedestals - there was no way the vibrator could be attached and the pedestal was too high to put on his vibrating table.

**SOLUTION:** VIBCO designed a special vise-grip bracket VC-130 with a V-130 ball vibrator attached to it. It made a fast and easy attachment to the flange and the vibrator could be easily moved up and down the seam. The pedestals now come out smooth and perfect every time. The bracket and vibrator were used on different forms with the same excellent results.

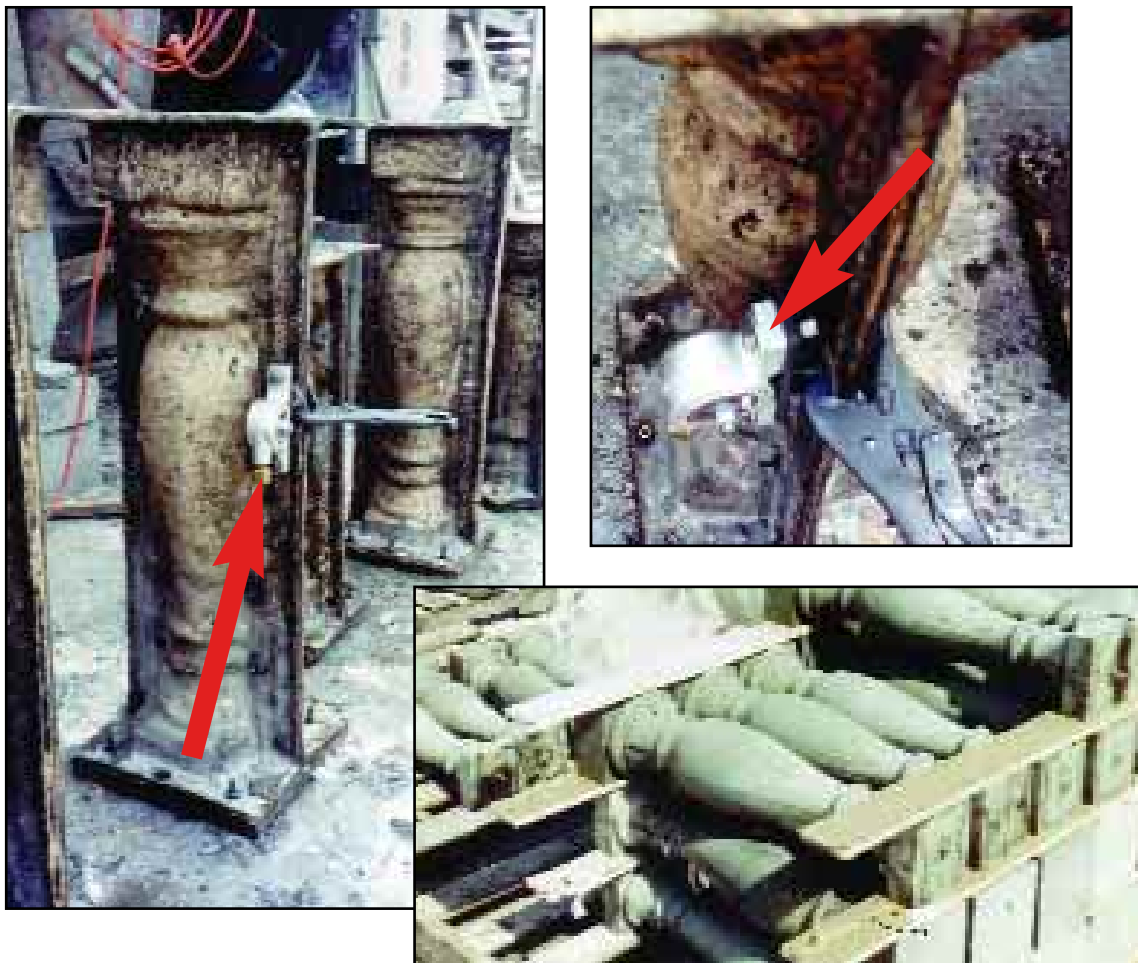

**Model VC-130 Vibrator and Vise Grip Bracket.**



**ORNAMENTAL CONCRETE PRODUCERS  
VIBRATING TABLES**

**PROBLEM:** Customer made his own vibrating table but could not get even vibration throughout table top. When using multiple forms, the ones in the middle of the table did not come out right and had to be scrapped.

**SOLUTION:** Customer purchased drawings for a version of VIBCO's patented "Live Top" table and built it to specifications. The "Live Top" table has virtually 100% equal vibration throughout the complete table top. All forms now put on the table come out perfect. Customer used model US-900 Electric 115 volt single phase 9000 RPM vibrator with speed adjuster for lighter or heavier loads.

VIBCO manufactures all kinds of vibrating tables designed for all kinds of molds. Let us quote you on your next table.



**CUSTOMER SAYS:** "I wasted a lot of my time and products. Glad I got VIBCO's help. I now do most of my forms on the table with excellent results."

**ASK FOR TABLE BROCHURE 7902.**

**PROBLEM:** 48" high x 10" square exposed aggregate pillars were impossible to vibrate internally due to the exposed aggregate. Customer was looking for other ways to produce his product.

**ANSWER:** A vibrating table large enough to hold the molds was constructed and two model 4P-1000 electric motor vibrators were used. The forms were moved down to the vibrating table on a roller conveyor put on the table – concrete was added (390 lbs.) and vibrated. Total fill and vibration time appr. 2 minutes.

**RESULT:** Good – 1800 RPM vibrators showed the best results. Higher frequency vibrators were also used but the upper layers of concrete did not get enough vibration. The higher amplitude low frequency 4P-1000 vibrators gave the best result.

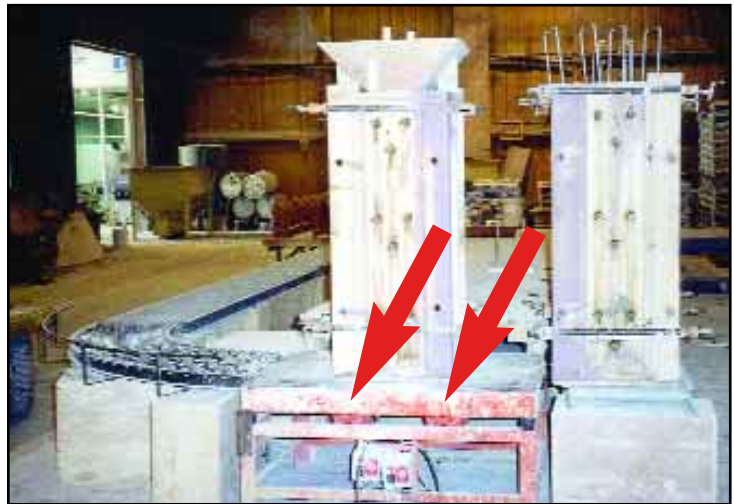

**DID YOU KNOW?**  
VIBCO was one of the first companies to develop portable vibrators.



**CUSTOMER:** William P. Smith for Edgecomb M.E.

**PROBLEM:** Problem with air entrapments in large (200 lb.) concrete lawn ornaments.

**SOLUTION:** A vibrating table was suggested but customer working alone had problems with moving the 200 plus mold when fired. Instead a portable vibrator was used. Model VS-320 Pneumatic vibrator (noiseless and needing no lubrication) was used and mounted on a large C-clamp and then fastened to the mold. This allowed the customer to leave the form in one place and move the vibrator from mold to mold.

**RESULT:** The product came out super-smooth with no air pockets.



- PATENTED "LIVE-TOP" WITH EVEN VIBRATION THROUGHOUT TABLE TOP
- ADJUSTABLE SPEED AND ADJUSTABLE FORCE
- MAKES THE PRODUCT PERFECT EVERY TIME

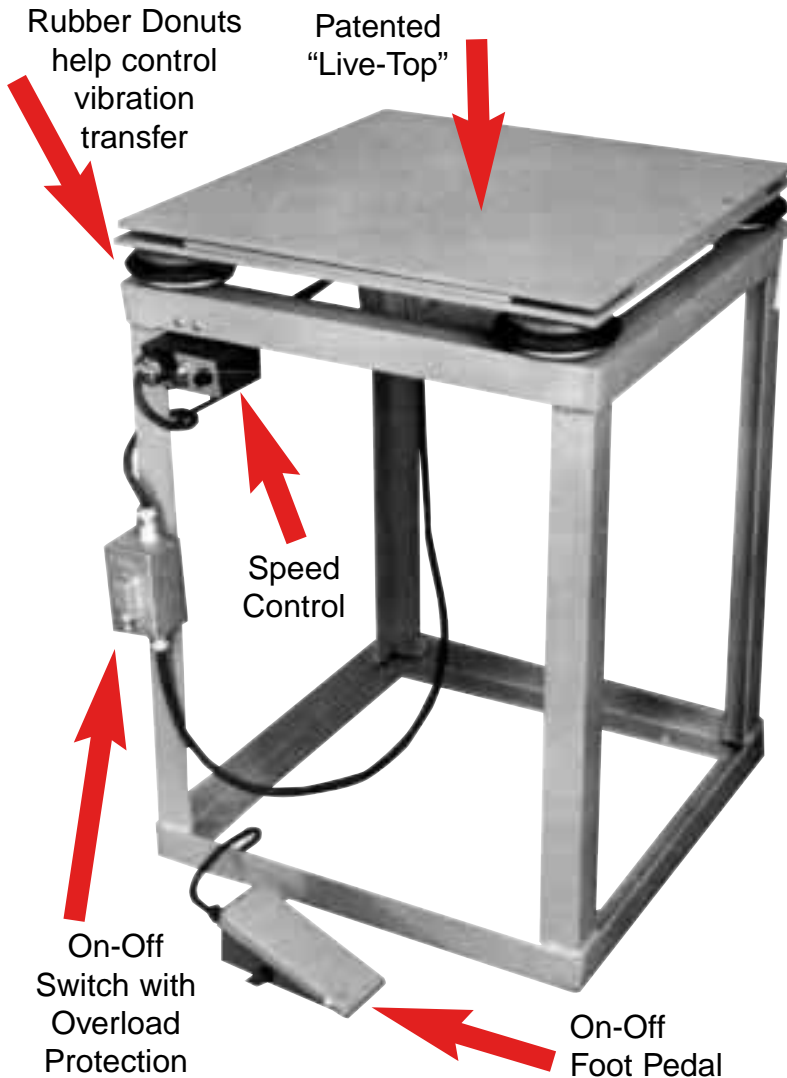

VIBCO's Patented "Live-Top" Table was designed by VIBCO engineers to eliminate the dead spot normally developing in the center of standard vibrating tables, insuring even and uniform vibration throughout the table top and product put on the table, whether small or large. Levels stiff mixtures in seconds, maintains uniform mixtures with minimum of air bubbles ideal for tile, pathstones, swimming pool coping, ornamental molds, etc.

VIBCO's "Live-Top" Table is equipped with a High Frequency Vibrator US-900 or US-1600 115 volt. Ready to be plugged into any light outlet, draws only max. 5 amps – Speed adjuster is supplied to change speed (frequency) from max 10000 to 0 – the "On-Off" switch with overload protection protects the vibrator from overload – Handy foot switch leaves hands free to handle product – inflatable rubber donuts for adjusting amplitude and vibration transfer through stand to floor.

VIBCO's "Live-Top" tables are supplied in the following table top sizes: 24 x 24", 30 x 30", 36 x 36" and 48 x 48". Vibrators are sized to weight of product and mold.

VIBCO's "Live-Top" tables are guaranteed for one year – and you can try a standard table free of charge for 10 days to make sure it will do the job you intended it for or you can return it. Your only obligation is to pay for the freight.

## Tile manufacturer uses 4 USRD 24 x 24 with Model US-900 Vibrators

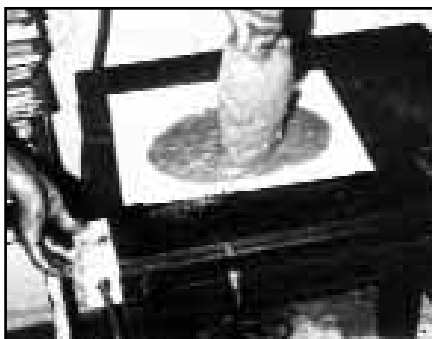

Mixture is poured into form on table. It is turned on for a few seconds.



The mixture is consolidated, air removed and glass like finish obtained.

FOR COMPLETE TABLE DETAILS ASK FOR CATALOG #7902D.

**VIBRATING ROLLER CONVEYOR TABLES**



Vibrating roller conveyor for increased production in cultured marble factory.

**12' LONG VIBRATING TABLE**



12' long vibrating table to handle multiple forms

**VIBRATING TABLE FOR LONG FORMS**



vibrating table with electric vibrators to handle a long 10,000 lbs. concrete form.

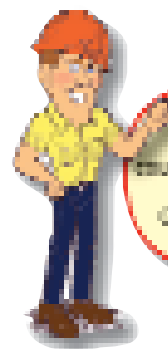

**DID YOU KNOW?**  
VIBCO has Sales & Service Centers located in  
every major city in the U.S. - Our Service & Training  
can be provided through our local office.  
Call or visit us at [www.vibco.com](http://www.vibco.com)  
to book a visit today!

**FLAT TOP TABLES**



**6' x 4' Table**

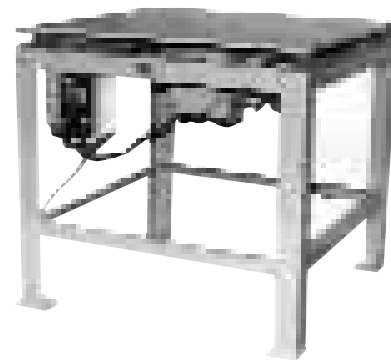

**48\"/>**

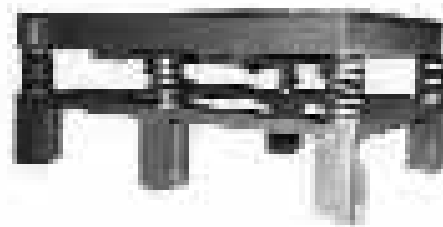

**Table for 5 ton concrete form**

**TILT TABLES**



**DID YOU KNOW?**

VIBCO has 4 locations across North America plus a nationwide dealer network. We can get you the right table for your job...and supply you with you need right away!



VIBCO provides pneumatic or electric vibrators for tilt-tables. Our engineering department will assist in selection and mounting of vibrators.

**VIBRA-BEAM  
Countertop System™**

- Produce a tight, dense and void-free finish ANYWHERE, in the shop or on the job
- Low cost alternative to a vibration table
- Easy to use, mounts to any standard sawhorse
- Incredibly portable, light-weight & small
- Versatile: use in precast, concrete countertops, patio stones, ornamental concrete and more

**Build Your Own  
Custom Vibrating  
Table with the  
VIBRA-BEAM  
Countertop  
System™**



The all new Vibra-Beam Countertop System™ is a state-of-the-art, patent pending countertop vibration system. This lightweight vibration system can be attached to any standard saw horse creating a high quality vibration table that produces a tight, dense and void-free finish of any concrete product. Available in either 115-volt power or pneumatic air, offering the lowest cost, portable solution available. The Vibra-Beam System can be adapted to fit any size countertop casting by simply adding additional Vibra-Beams.



VIBCO recommends installing two Vibra-Beam units for each 4 to 8 foot section of countertop.

100% made in the USA, the design for the Vibra-Beam Countertop System™ draws from some of the best qualities of VIBCO's time-tested, industry standard, larger vibration table. Scaled down to be easily portable for smaller applications, the Vibra-Beam still provides the quality-engineered product for which VIBCO is known.

**ASK FOR  
A FREE  
TRIAL  
TODAY!**

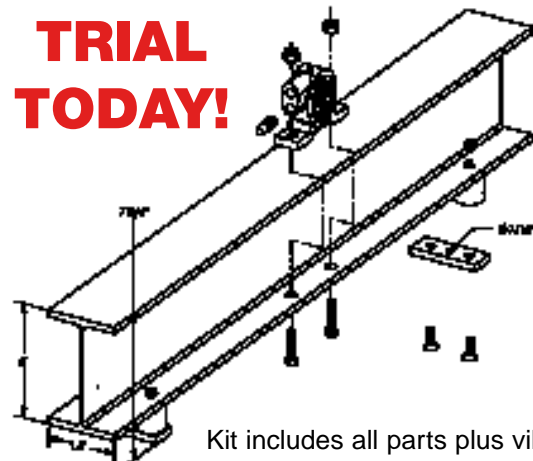

Kit includes all parts plus vibrator necessary for mounting to your own sawhorse.

## **SELF PROPELLED SCREEDS**

A vibrating screed is a frequently used tool for striking off and compacting concrete floors, beams, walkways, etc., to obtain a smooth surface finish, good consolidation and strength of concrete. Penetration up to 6 to 8" can be achieved.

Screeds are frequently "homemade" by the user. By following a few simple rules they can be made almost "self-propelled", only needing a guiding hand instead of having to be pulled or pushed.



**Model CCF-5000 Silent Pneumatic Vibrator on 10 ft. screed.**

To make the screed "self-powered" mount the vibrator 2" off the centerline and make sure the vibrator rotation is counter clockwise. Another simple screed made by 2" tubing is shown on next page.

### **DID YOU KNOW?**

VIBCO Silent Turbine vibrators can significantly reduce the noise level at your near jobsite.



### **DID YOU KNOW?**

VIBCO Silent Turbine vibrators reduce the noise level at your jobsite. Contact your distributor for more information. Call 800-633-0032 or go online to [www.vibco.com](http://www.vibco.com) to stock & visit today!

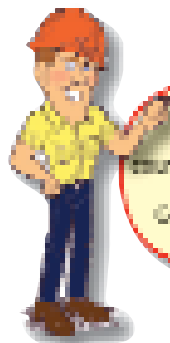

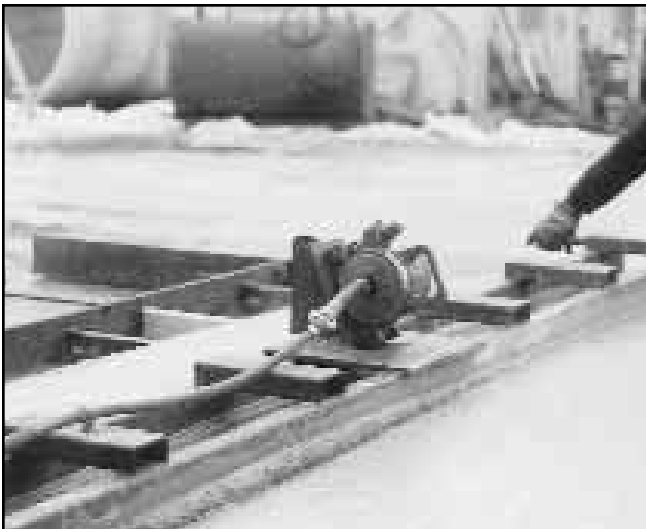

12' Screed with **SVRL** Air Vibrator, made from 2 x 4" steel tubing.



**Model 2P-800** on 8' screed, made from a 6" channel iron with adjustable rods to minimize the bowing of the screed.



**BVS-510FS Turbine Vibrator** on 4" screed, made from 4" channel iron.

Self-propelled feature is accomplished by mounting vibrator 2 to 4" of center. If you slot holes screed travel rate can be regulated by moving away from or towards center of screed. **NOTE:** Vibrator shaft must rotate as shown in sketch.

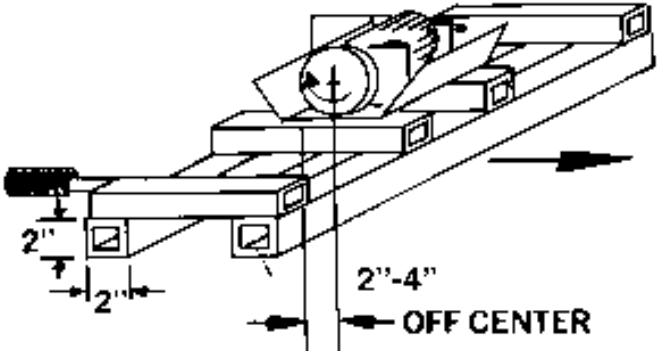

Screed made from 2" x 4" steel tubing and **Model 2P-450 Electric Vibrator**.

**VIBRATION SCREED GUIDE**

Length	Electric Vibrator	Pneumatic Vibrator
4-6'	US-900 US-1600 2P-200	BVS-510 SVR-4000 CCF-2000
6-8'	2- US-1600 2P-450	2- BVS-510 BVS-570 SVR-4000, CCF-2000
8-10'	2P-800	SVRL-5500, CCF-5000 2- SVR-4000, 2- CCF-2000



## US-100 ON CONCRETE BULLFLOAT FOR MAKING SIDEWALK

**PROBLEM:** Exposed aggregate sidewalk came out uneven.

**SOLUTION:** US-100 vibrator with speed adjuster was mounted on concrete float.

**CUSTOMER COMMENT:** We now get an even spread of aggregate, our sidewalks come out beautifully.



Embedding the rock



Finished sidewalk after it is washed.

## OTHER SCREED APPLICATIONS:



Screed with Model 50-1-1/4 pneumatic piston vibrator



Screed using a 2 x 4 and a pneumatic VS-350 vibrator



**46" Steel Grid Tamper** with expanded, round hole or diamond steel mesh with pneumatic turbine



**TG-1**, 12 x 18" with 2" Pneumatic Piston Vibrator



**TG-2**, 12 x 18" shown with **US-450** (option **US-900** Electric Vibrator)

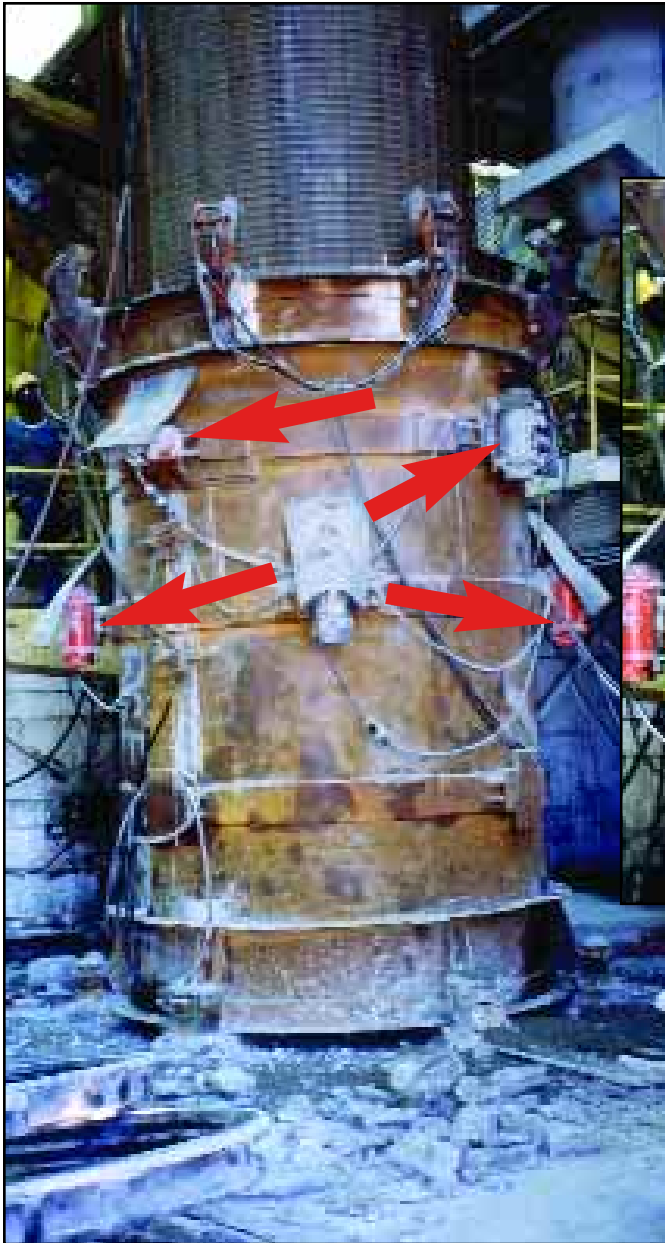

## LARGE CONCRETE PIPE FORMS

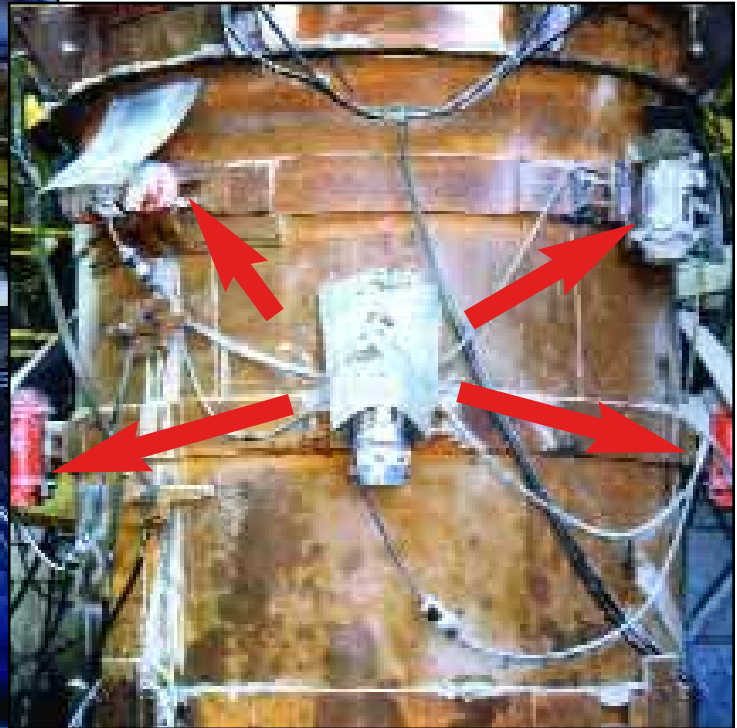

### DID YOU KNOW?

VIBCO offers free plant surveys.  
Call 800-633-0032 today  
to set up an appointment!

## VIBRATORS MOST COMMONLY USED

**PNEUMATIC:** The High Frequency Model SVRL(S)-4000, 5500, 8000 are by far the most popular vibrators for large concrete pipe. These units require the least amount of maintenance, are light and easily portable. The high frequency will place the concrete fast, give excellent surface finish and strength. (See page 6 & 7 for technical data).

**ELECTRIC:** VIBCO Model 2P-3500 and 2P-5500 totally enclosed units are especially designed for the concrete pipe industry. These units have adjustable force up to 4500 lbs. for 2P-3500, 5500 lbs. for 2P-4500, and 6500 lbs. for 2P-5500. These units have specially treated windings to withstand mechanical failure and Class F High Temperature insulation to withstand considerable overload. These units have two roller bearings for long life. They can be mounted with rotor shaft vertically or horizontally. They are made in the U.S. and follow NEMA & ASTM standards. All parts are available from the factory. (See page 16 and 17 for technical data.)

## MISC. SMALL PIPE FORMS



High slump concrete using **SVRWS-4000** (page 3). High frequency pneumatic vibration was used. VWF-female brackets were welded to form - 2 per form - one low and one high - opposite sides.



**Model SVRLS-5500** on pipe form.



**Model SVRLS-6500** on pipe form.

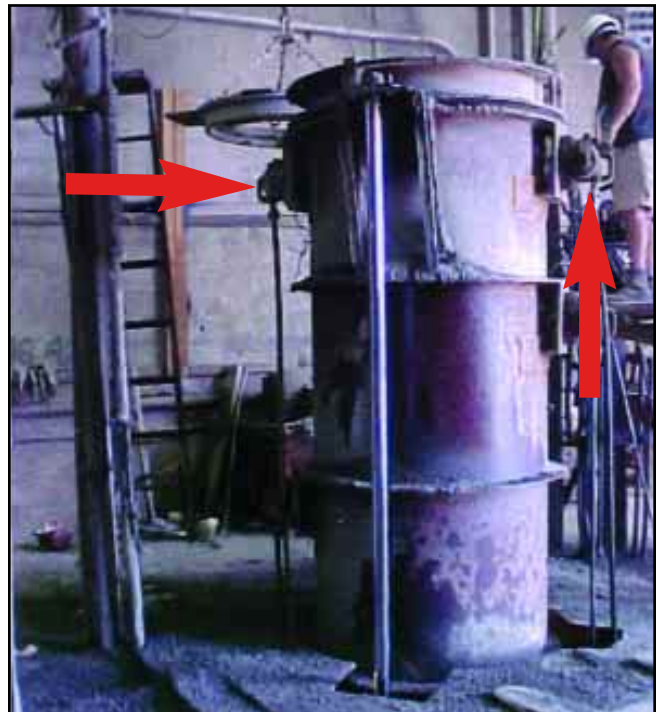

**Model SVRLS-6500** on pipe form.

## SELECTION OF VIBRATORS

### GENERAL RULE FOR MISC. SMALL PIPE FORMS:

3-6" Slump (from ready mix truck) - vibrator force needed - same as total weight of concrete and form—vibrators to be used. 2P-Line of heavy duty electric vibrators and US-Line (page 16-17), pneumatic type model SVRL, CCL & VS lines (page 2-16).









0-2" Stiff concrete - vibrator force needed 2 times total weight of concrete and form. **NOTE:** Vibrators must be placed within a 3' radius of each other, high frequency vibrators must be used to make concrete flow and consolidate. Vibrators to be used US-Line of electric (page 16-17) pneumatic SVR-Line of high frequency (page 14-15).

**VIBCO'S APPLICATION ENGINEERS WILL HELP YOU WITH SELECTION AND MOUNTING.**



## APPLICATION SUGGESTIONS

1. Vibrators are placed 5' to 10' apart on alternate side of form. Spacing depends on height of form and slump of concrete. Start by mounting vibrators 2 to 3' from the ends, 16 to 24" from bottom.
2. Start vibrators when concrete reaches 6" to 10" above them. Continue vibrating until a flat glistening surface appears on top and no more air bubbles break on surface.
3. The most popular vibrators for the prestressed and precast industries where a large mass of concrete has to be vibrated are the high frequency pneumatic SVR line (p14-15). An alternative in the electric line is the 2P, 3600 rpm, 3-phase units (p16-17).

MODEL	FACTORS	DISTANCE IN FEET BETWEEN VIBRATORS; VIBRATORS ON ALTERNATING SIDES									
		 SINGLE T	 DOUBLE T	 INVERT T	 BEAM & GIRDER	 SLAB & COLUMN GIRDER - WALL, FORM	 TILT UP PANEL	 HOLLOW CORE	 VERTICAL BATTERY SECTION		
STVL-1000*	A		12'	5'					6'		
	B		12'	6'	6'	8'	10'	5'	10'		
	C		12'	6'	6'	8'	10'		12'		
STVL-1000* & 1000*	A'	12'	10'		12'	6'	8'	15'	10'	16'	24'
	B	12'	10'		12'	6'	8'	15'	10'	16'	24'
	C	12'	12'		12'	6'	8'	15'	10'	16'	24'
STVL-1000*	A	12'	12'		12'	12'	12'	12'	12'	16'	24'

\*Based on 3"-5" slump concrete, steel form, "average" conditions. Other shapes and conditions see "General Guide" on next page.

**ARE YOU KNOW?**  
 VIBCO is the only VIBCO distributor in your area!  
 Call 800-633-0032 at any time.  
 We're always on top!



## SINGLE T



**SVRLS-5500** Vibrator every 10' alternating sides. Stiffen wall with 8 or 10" channel. Do not use original stiffeners for vibrator mount.

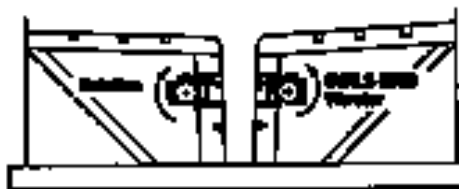

Vibrators mounted high on stem. Spacing: 12' alternating sides on 8' T. 10' on 10' T.

## DOUBLE T

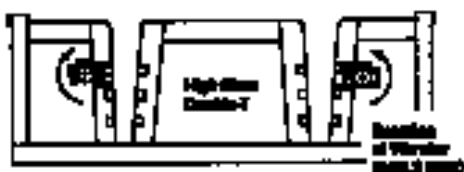

Permanently mounted **SVRFS-5500** is spaced 18' on alternating sides. Use of isolation mounts to "float" form is recommended. On all high stem forms vibrators are mounted close to wing of T. Alternate vibrator **SVRLS-5500**.



Add I-Beam or channel iron for strength and vibrator mount. Use **SVRLS-5500** with **LC** mount. For permanent mount use **SVRFS-4000** Vibrator for extra fine finish.

## INVERTED T

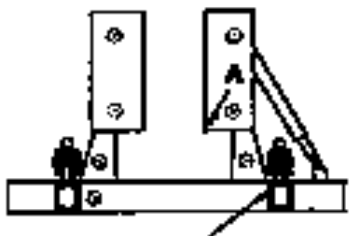

**SVRLS-5500** vibrator is used with **LC**-mounting bracket. Construct a box of 2 channel irons for sturdy vibrator mount. Spacing 9' alternating sides. Alternate mount is to place vibrators at A. For **SVRLS-8000** use 10' - 12' spacing.

## GIRDER

**SVRLS-5500** vibrator is used. Mounted on 6" channel with **LC**-bracket welded to form side just above slope portion.

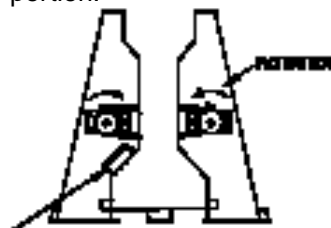

Alternate mounting for vibrator good for removing trapped air on inverse surface.

## DUAL PILING

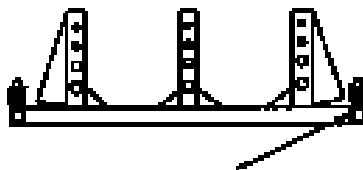

**SVRLS-5500** construct channel iron box for mounting vibrator. High force vibration is necessary to transfer across this wide form. Spacing: 10' on alternating sides. 12' where **SVRLS-8000** is selected.

## 12 & 24 Volt DC

- Totally enclosed
- Double armoured housing
- Watertight
- Continuous duty

**Model  
DC-500**



The **DC-500** is o-ring sealed for power washdown and designed with completely smooth surface to help eliminate most of the concrete buildup. Double armoured housing protects motor parts and withstands rapping with cleaning tools. Cable inlet on bottom eliminates cable hangups and breakage. Cable is also protected by a plastic hose. Replaces Bosch Model 19861.

### **OTHER PUMP VIBRATORS** (for technical data see General Catalog)



**DC-100**



**HLF-700**

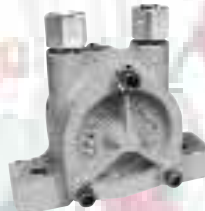

**B-250, B-320**



**BV-250, BV-320**

**ELECTRIC:** All units 12 or 24 volt DC, sealed to handle the environment, application proven for quality and long life.

**PNEUMATIC:** BV-250 and 320 can be run off your truck's air supply. Lubrication required. Equipped with threaded exhaust for muffler or for connecting a hose to lead off air.

**HYDRAULIC:** B-250 and 320 turbine design, discharge is direct to oil reservoir. HLF-700 connects directly to hydraulic system.

**SELECTION:** DC-500, HLS-700, BVS-320 on truck mounted pumps. DC-100, B-250, BVS-250 on trailer mounted pumps.



**Model BVS-320** on trailer mounted pump.



**Model DC-500** vibrator on top of grid.



**Model DC-200** vibrator under screen.

Rule of thumb for sizing vibrators for bins and hoppers: figure out total weight of material in sloping portion of the bin or hopper and divide weight by 10. This figure is the total force needed on the vibrator or vibrators to be selected. (For more information, see General Catalog or Catalog #9803: Vibrators for Sand and Gravel and Ready Mix Concrete Procedures. Use vibrators with 3600 VPM for coarse material such as sand, etc. Over 5000 VPM for fine fluffy materials such as cement, etc.

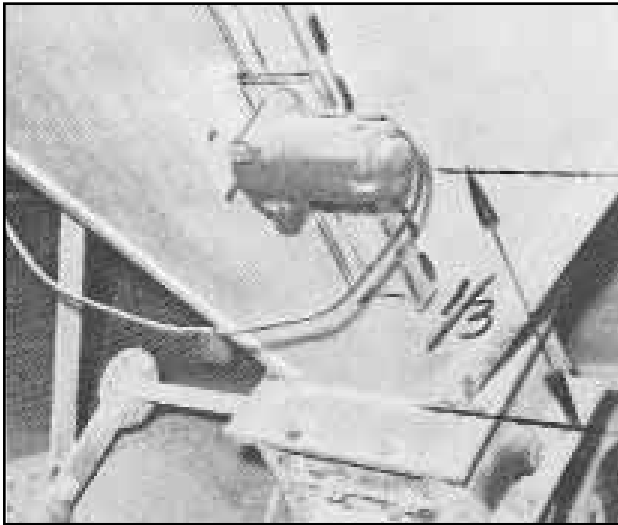

## CEMENT WEIGH BATCHER

Customer had problem emptying weigh batcher which caused scale inaccuracies, improper mixes and delays in loading. The old fashioned rap-with-a-hammer solution was slow and caused damage to the batcher wall. VIBCO's **Model US-450** 115 volt electric vibrator was mounted on the hopper. See pictures and diagrams. Vibrator was plugged into available light outlet and with a switch, operator turns on vibrator when loading a truck and off when dial scale reads zero. (Comparable pneumatic vibrator **Model VS-320** silent turbine or **Model 55-1-1/2 Piston**). Customer now gets reliable mixes and no delivery or loading delays.

## SAND BIN

Customer had problem with wet sand sticking to bin sides.

A **Model 2P-800** electric vibrator was mounted to bin side.



See photo and mounting diagram. Sand now moves freely - customer has no further problems.

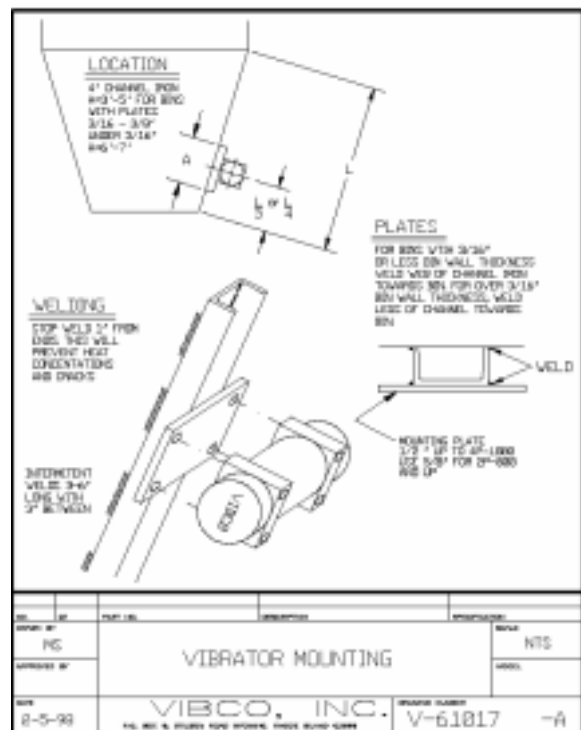
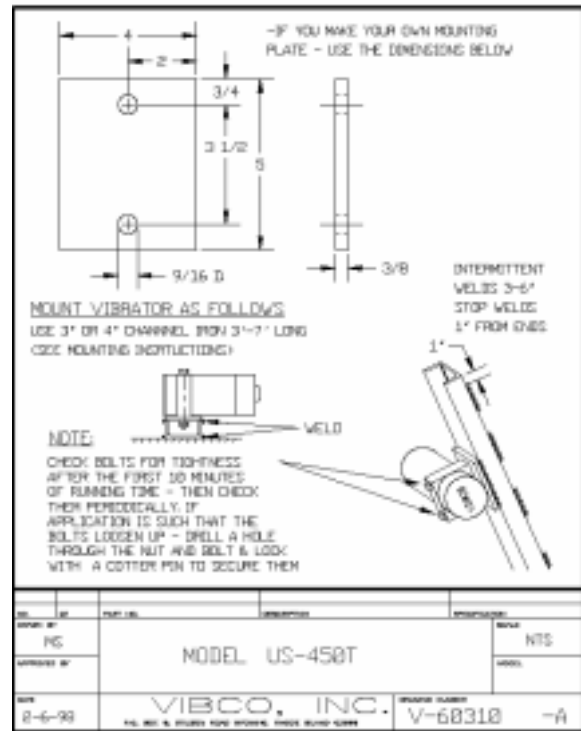

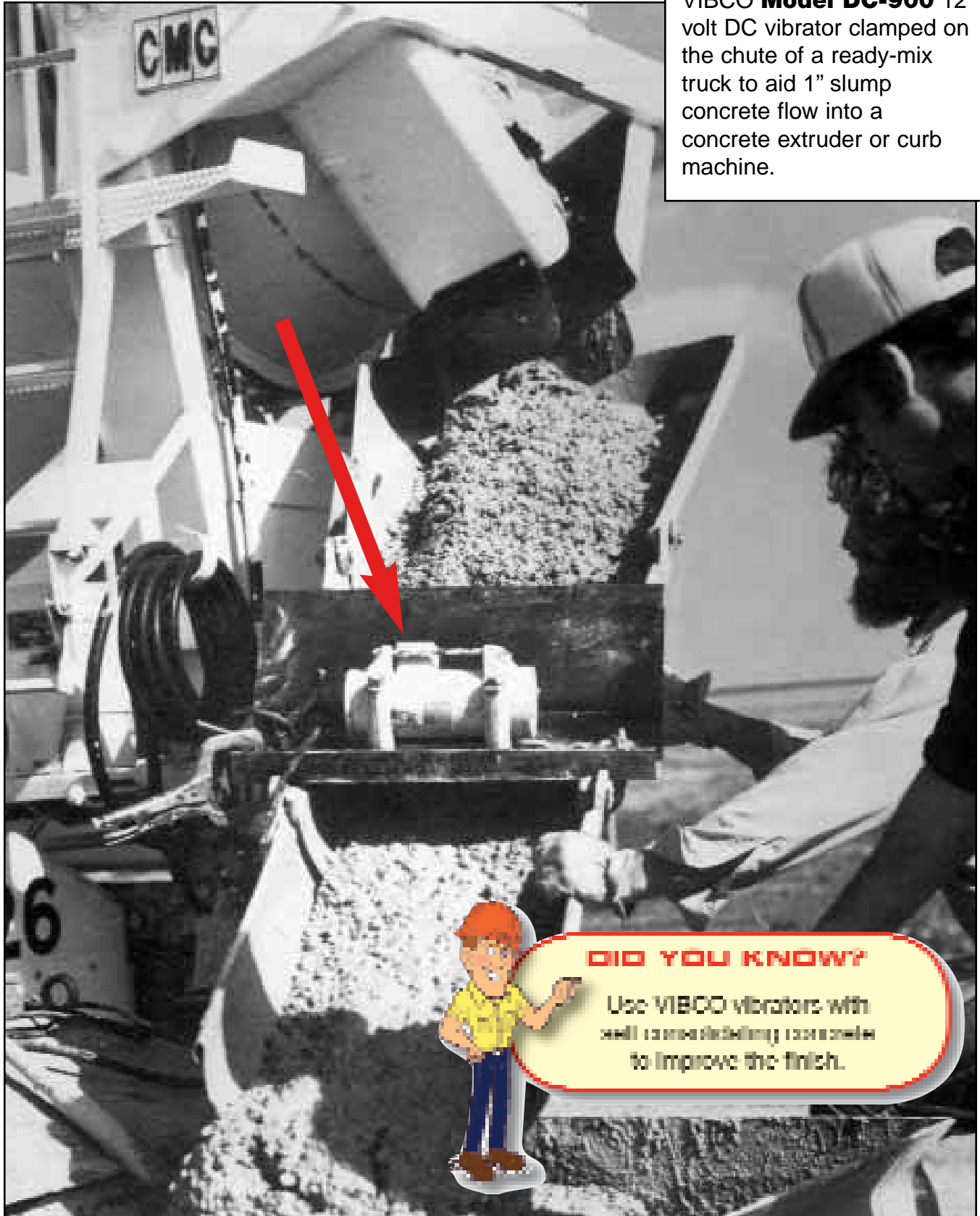

VIBCO **Model DC-900** 12 volt DC vibrator clamped on the chute of a ready-mix truck to aid 1" slump concrete flow into a concrete extruder or curb machine.

**DID YOU KNOW?**

Use VIBCO vibrators with well consolidated concrete to improve the finish.



## Charge Hopper Build-up is Costly and Time Consuming for Ready Mix Truckers

Problem solved by installing Model VS-250 Air Operated Vibrator

- Prevents sand build-up • Low cost and silent
- Reduces batch time and reduces spillage by reducing sand build-up



**VIBCO VS-250** air vibrator mounted on the charge hopper of a front discharge mixer truck. (Complete kit available.)

**CUSTOMER COMMENTS:** "This small vibrator does a great job by preventing build-up in the charge hopper. I don't have to shovel like I did before. I'm glad they have decided to put one of these vibrators on all the trucks."



## Concrete Clogging Discharge Chute on Transit Mixers

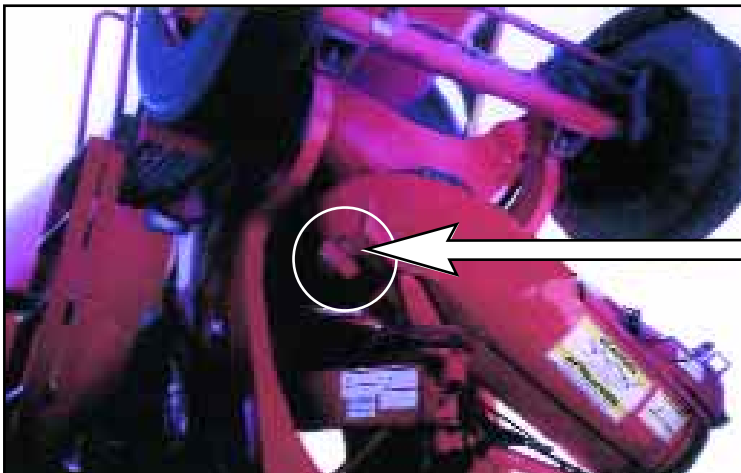

**Standard aluminum housing** - Note: comparable pneumatic unit also available.

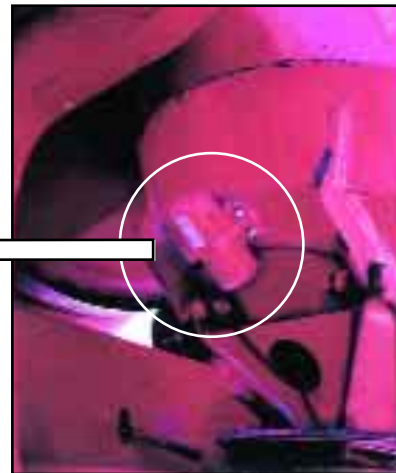

**DC-60** mounted on back side of chute

**CUSTOMER COMMENTS:** "This small 12 volt DC-vibrator solved two problems for us. It cleaned out the material that had built-up behind the rubber boot and it eliminated the hazards the operator faced when climbing up on the truck to clean out the chute. When delivering a stiff mix, the vibrator made the concrete flow like water. We have now installed DC-60 vibrators on our complete fleet." (Complete kit available.)

**Model DC-3500  
12 Volt DC  
Battery  
Operated**

# **BIG BERTHA**

**DUMP CLEAN  
DUMP FAST**



Dump clean without having to bang and slam the tailgate. No more shoveling out loads that get stuck. VIBCO's Big Bertha DC-3500 vibrator works fast! Delivering 3500 lbs. of force to release the most stubborn loads. Big Bertha DC-3500 comes with all mounting hardware for quick and easy installation.

**ASK FOR CATALOG #9112.**

# VIBCO

VIBRATION PRODUCTS

## INTERNAL CONCRETE VIBRATORS

SIMPLICITY & VERSATILITY  
FOR LONG LIFE



### FEATURES:

- MOTOR UL LISTED
- DROP TESTED AT OVER 6 FEET
- WATERPROOF SWITCH
- WRAP AROUND PROTECTIVE FRAME
- LARGE RUBBER SHOCKS
- SHOULDER PACK INCLUDED
- HEAVY DUTY BRUSHES



**FOR MORE  
INFORMATION**

Call **800-633-0032**

eMail

**[vibrators@vibco.com](mailto:vibrators@vibco.com)**

Go online to

**[www.vibco.com](http://www.vibco.com)**



**Corporate Headquarters & Factory:**

75 Stilson Road, P.O. Box 8  
Wyoming, RI 02898

**Phone: 800-633-0032 • 401-539-2392 Fax: 401-539-2584**

**Western US Office:**

Phoenix, AZ 85254

**Phone: 800-633-0032 • 480-596-1809 Fax: 480-596-1614**

**Southeastern US Office:**

Charlotte, NC 28104

**Phone: 800-633-0032 • 401-864-8400 Fax: 480-596-1614**

**Canada Office:**

2215 Dunwin Drive  
Mississauga, ONT L5L 1X1

**Phone: 800-465-9709 • 905-828-4191 Fax: 905-828-5015**

**[www.vibco.com](http://www.vibco.com) • [vibrators@vibco.com](mailto:vibrators@vibco.com)**

